



CENNIK

PRICELIST

Aktualny od ▪ *Valid from:* 1.02.2022

CENY PODANE W CENNIKU NIE ZAWIERAJĄ PODATKU VAT
RATES IN THIS PRICELIST ARE NET PRICES

Przyjmujemy realizację płatności za zakupione towary i usługi kartami płatniczymi i kredytowymi.
We accept debit and credit cards as payment for purchased goods and services.



LINDAB	10
Zawory wentylacyjne Lindab Airy <i>Lindab Airy air valves</i>	12
Nawiewniki/wywiewniki <i>Diffusers</i>	13
Skrzynki rozprężne, przewody tłumiące, kratki <i>Plenum boxes, flexible silencers, grilles</i>	16
Smart Tools	17
Wybrane produkty dostępne na zapytanie ofertowe	18



KANAŁY WENTYLACYJNE OKRĄGŁE **VENTILATION ROUND DUCTS**

Rury zwijane <i>Circular ducts</i>	20
SPIRBOX - bezpieczny system transportu rur zwijanych SPIRO® <i>SPIRBOX - Pipe transportation</i>	22
Mocowanie kanału <i>Duct support</i>	23



KSZTAŁTKI WENTYLACYJNE OKRĄGŁE **VENTILATION ROUND FITTINGS**

Kolana tłoczone <i>Pressed bends</i>	24
Kolana segmentowe <i>Segmented bends</i>	26
Redukcje tłoczone <i>Pressed reducers</i>	28
Redukcje segmentowe <i>Hand made reducers</i>	30
Trójniki symetryczne, Trójniki niesymetryczne, Trójniki orłowe <i>T-pieces, Twin bends</i>	32
Sztucery siodłowe <i>Collar saddles</i>	38
Sztucery, Nyple, Mufy, Zaślepki <i>Collars, Coupling, Duct end caps</i>	39
Sztucery cylindryczne <i>Branchings</i>	46

* nowość w cenniku - new



ELASTYCZNE PRZEWODY WENTYLACYJNE
VENTILATION FLEXIBLE DUCTS

Przewód półelastyczny S-Flex® <i>S-Flex® Semi-rigid aluminium ducts</i>	49
Elastyczne przewody wentylacyjne <i>Aluminium flexible ducts</i>	50
Otulina Sleeve, Elastyczne przewody PVC <i>Insulation Sleeve, Flexible PVC ducts</i>	51



KANAŁY I KSZTAŁTKI WENTYLACYJNE PROSTOKĄTNE
RECTANGULAR DUCTS AND FITTINGS

Kanały i kształtki prostokątne typu AI <i>Rectangular ducts and fittings, type AI</i>	53
--	-----------



SYSTEM WENTYLACJI ROZDZIELACZOWEJ
INTEGRATED MANIFOLD DISTRIBUTION VENTILATION SYSTEM

Elastyczny przewód dwuwarstwowy <i>Double layer elastic duct</i>	54
Rozdzielacze przelotowe dwurzędowe <i>Double row through manifolds</i>	55
Rozdzielacze kątowe jednorzędowe i niesymetryczne <i>Single row and asymmetric angular manifolds</i>	56
Skrzynki rozprężne SR-T <i>Plenum boxes SR-T</i>	57



PRZEPUSTNICE WENTYLACYJNE
DAMPERS

Przepustnice jednopłaszczyznowe okrągłe <i>Circular duct dampers</i>	58
Przepustnice IRIS, zwrotne, nastawne regulatory stałego przepływu <i>Duct damper type IRIS, back draft dampers, flow regulators</i>	60
Przepustnice wielopłaszczyznowe i samoczynne aluminiowe <i>Multi-leaf and automatic aluminium dampers</i>	63

* nowość w cenniku - new



OSPRZĘT WENTYLACYJNY VENTILATION EQUIPMENT

Czerpnie / wyrzutnie prostokątne i okrągłe <i>Rectangular and round air intakes/exhausters</i>	65
Klapy rewizyjne <i>Access doors</i>	69
Nasady kominowe, kominki, podstawy dachowe <i>Chimney roots, ventilation caps, roof base</i>	70
Filtry kanałowe szufladowe i okrągłe <i>Round duct and cassette filters</i>	74
Kratki - typ AI <i>Grilles - type AI</i>	75
Króćce elastyczne prostokątne i okrągłe <i>Rectangular and circular flexible duct connectors</i>	76



TŁUMIKI AKUSTYCZNE ACOUSTIC SILENCERS

Tłumiki akustyczne okrągłe <i>Circular silencers</i>	77
Łącznik półelastyczny, tłumiki akustyczne płytowe <i>Semiflexible connector, rectangular silencers</i>	78



MATERIAŁY MONTAŻOWE ASSEMBLY MATERIALS

Obejmy do rur <i>Pipe clips for round ducts</i>	81
Opaski zaciskowe, opaski montażowe <i>Band clip, supressing bands</i>	82
Zawiesia, nakrętki złączne, pręty gwintowane <i>Suspension, connecting nuts, threaded rods</i>	83
Konsole kątowe, blachowkręty, tuleje kotwiące <i>Consoles, self-drilling screws, anchor bushes</i>	85
Zacisk kanału, podstawa profilu, końcówki do blachowkrętów <i>Duct clips, profile base, terminals for screws</i>	86
Silikon, uszczelki, śruby dwugwintowe, pianka montażowa, śruby <i>Silicone, self-adhesive seals, double-threaded screws, assembly foam, screws</i>	87

* nowość w cenniku - new

Nakrętki, taśmy perforowane, podkładki, guma amortyzująca <i>Nuts, Perforates suspension banding, washers, shock absorbing rubber</i>	88
Kształtowniki <i>Support channels</i>	89
Lindab SolidFoot Uniwersalny system podstaw i wsporników montażowych do urządzeń HVAC <i>Universal base and supports system for HVAC units</i>	90



MATERIAŁY PRODUKCYJNE
PRODUCTION PROFILES

Profile kanałowe, narożniki do profili <i>Ductwork profiles, corners</i>	94
Siatka ocynkowana 12×12, Rurka usztywniająca aluminiowa <i>Galvanized steel 12x12 mesh, stiffening aluminium pipe</i>	95
Dyski usztywniające, krzyżak usztywniający <i>Stiffening discs, stiffening steel cross</i>	95
Cynk w sprayu, masa uszczelniająca <i>Alu-Zinc spray, tightening compound</i>	95
Mechanizmy przepustnic, łączniki elastyczne <i>Damper mechanisms, flexible connectors</i>	96
Rączka mechaniczna przepustnicy, kołnierze <i>Damper hand, flanges</i>	97
Elementy produkcyjne przepustnic wielopłaszczyznowych aluminiowych odpornych na temperaturę <i>Production elements of the air tight aluminium multi-leaf dampers</i>	98
Elementy produkcyjne przepustnic wielopłaszczyznowych aluminiowych <i>Production elements of the aluminium multi-leaf dampers</i>	99
Elementy produkcyjne wyrzutni i czerpni prostokątnych aluminiowych i stalowych <i>Production elements of the aluminium and steel rectangular air- intakes and exhausters</i>	100
Elementy produkcyjne przepustnic samoczynnych <i>Production elements of automatic aluminium dampers</i>	101



MATERIAŁY IZOLACYJNE
INSULATION MATERIALS

Izolacje techniczne VENTWOOL <i>VENTwool technical insulation</i>	102
--	------------

* nowość w cenniku - new

Izolacje techniczne ROCKWOOL <i>ROCKWOOL technical insulation</i>	103
Gwoździe samoprzylepne <i>Self-adhesive nails</i>	105
Mata termoizolacyjna kauczukowa MST <i>Selfadhesive Thermo Insulating Matt</i>	106
Taśmy <i>Tapes</i>	106



ANEMOSTATY, NAWIEWNIKI, KRATKI, ZAWORY POWIETRZNE
DIFFUSERS, GRILLES, VALVES

Zawory powietrzne <i>Air valves</i>	107
Anemostaty sufitowe prostokątne HB40 <i>Square ceiling diffusers HB40</i>	110
Anemostaty sufitowe okrągłe DS <i>Round ceiling diffusers DS</i>	110
Anemostaty wirowe SW, SD-B, SD-C <i>Swirl diffusers SW, SD-B, SD-C</i>	111
Anemostaty sufitowe prostokątne ASN, ASW <i>ASN/ASW rectangular ceiling diffusers</i>	113
Dysze dalekiego zasięgu JNS <i>Jet diffusers JNS</i>	115
Skrzynki rozprężne i przyłącza montażowe <i>Plenum boxes and round ceiling diffusers</i>	116
Kratki ścienne aluminiowe <i>Aluminium wall grilles</i>	119
Kratki ścienne KSH, KSV, KWP <i>Wall grilles KSH, KSV, KWP</i>	120
Maskownice M, Kratki z siatką KWS <i>Frames M, grilles with mesh KWS</i>	125
Kratki podłogowe KNP <i>Floor grilles KNP</i>	126
Kratki wentylacyjne osłonowe maskujące KST <i>Grilles with fixed blades KST</i>	127
Kratki wentylacyjne na kanał zwijany <i>Grilles for the coil duct</i>	128

* nowość w cenniku - new



CENTRALE WENTYLACYJNE AIR HANDLING UNITS

Centrale wentylacyjne SALDA <i>SALDA air handling units</i>	130
Centrale wentylacyjne VENT-AXIA <i>VENT-AXIA air handling units</i>	150



NAGRZEWNICE POWIETRZA AIR-HEATERS

Nagrzewnice wodne i elektryczne SALDA <i>SALDA water and electrical heaters</i>	152
Nagrzewnice wodne FLOWAIR <i>FLOWAIR water heaters</i>	153



WENTYLATORY FANS

Wentylatory Vent4U <i>Vent4U fans</i>	162
Wentylatory Salda <i>Salda fans</i>	163
Nagrzewnice i wentylatory S&P, Venture Industries <i>S&P, Venture Industries air-heaters and fans</i>	168
Wentylatory, podstawy dachowe i wywietrzaki Uniwersal <i>Uniwarsal fans, roof base and graviation fans</i>	176
Wentylatory Systemair <i>Systemair fans</i>	178
Wentylatory Rosenberg <i>Rosenberg fans</i>	179



KLAPY PRZECIWOŻAROWE FIRE DAMPER

Klapy przeciwpożarowe okrągłe i prostokątne LINDAB <i>LINDAB round and rectangular fire dampers</i>	180
--	-----

* nowość w cenniku - new

Klapy przeciwpożarowe okrągłe SMAY
SMAY round and rectangular fire dampers **188**

Klapy przeciwpożarowe okrągłe MERCOR
MERCOR round and rectangular fire dampers **189**



SIŁOWNIKI
ACTUATORS

Siłowniki do przepustnic LUFBERG
Actuators for dampers LUFBERG **190**

Siłowniki do przepustnic BELIMO
Actuators for dampers BELIMO **193**



KLIMATYZATORY
AIR-CONDITIONERS

Klimatyzatory TCL
TCL air-conditioners **196**

Klimatyzatory Mistral
Mistral air-conditioners **199**



MATERIAŁY MONTAŻOWE DO KLIMATYZATORÓW
ASSEMBLY ACCESSORIES FOR THE AIR-CONDITIONERS

Rury miedziane chłodnicze
Cooling copper pipes **201**

Czynniki chłodnicze
Refrigerants **202**

Mocowania skraplacza
Condenser's fastening **203**

Koryta montażowe, kształtki montażowe PVC
PVC assembly trays, PVC assembly profiles **204**

Rura do odprowadzania skroplin, pompka skroplin
Pipe for drips, drainage pump **208**

Środki do czyszczenia i konserwacji urządzeń klimatyzacyjnych
Cleaning and maintenance agents for air-conditioning devices **208**

* nowość w cenniku - new

Opakowanie zbiorcze <i>Collective packaging measurements</i>	209
Warunki dostaw w Polsce <i>Terms of delivery in Poland</i>	210

Sprzedaż produktów przez Lindab Sp. z o.o. z siedzibą w Wieruchowie odbywa się na zasadach określonych w dokumencie **Ogólne warunki sprzedaży produktów Lindab Sp. z o.o.** zamieszczonym na stronach internetowych www.lindab.pl i www.lindab-polska.pl, a także dostępnym w biurze sprzedaży Lindab Sp. z o.o.

* nowość w cenniku - *new*



Od przeszło 50 lat Lindab tworzy i rozwija produkty stosowane do tworzenia wszelkiego rodzaju systemów wentylacyjnych. Dzięki bogatemu doświadczeniu zdobytego na różnych rynkach oraz na podstawie badań przeprowadzanych we własnych laboratoriach, Lindab tworzy produkty o najwyższej jakości i funkcjonalności. Dbalność o szczegóły, niezawodność, przyjazność środowisku to wartości jakie przyświecają nam na każdym etapie tworzenia produktów. Lindab posiada w swojej ofercie kompletne rozwiązania systemowe, które można podzielić na 3 główne grupy produktowe: Air Duct Systems, Comfort, Rozwiązania IT.

Air Duct Systems - system przepływu powietrza

Do obszaru produktowego ADS zaliczamy kanały i kształtki o przekroju okrągłym, uzupełnione systemami prostokątnymi oraz kominkami wentylacyjnymi. W tej grupie dostępne są również specjalistyczne rozwiązania systemów wentylacyjnych takie jak wykonania np. z blachy kwasoodpornej, systemy do transportu pneumatycznego (Lindab Transfer) czy systemy kanałów preizolowanych (Lindab ISOL) .





Lindab Comfort

Produkty przyczyniające się do tworzenia komfortowego i zdrowego klimatu wewnątrz, podzielone są na trzy podgrupy: **Airborn Solutions** - produkty, które dostarczają i odprowadzają powietrze z wentylowanego obszaru takie jak kratki, nawiewniki, anemostaty, **Waterborne Solutions** - produkty do wentylacji i klimatyzacji pomieszczeń takie jak: belki chłodzące aktywne i pasywne, panele grzewczo-chłodzące, aparaty indukcyjne, **Acoustic Solutions** - wybór tłumików do komfortowego, cichego systemu wentylacyjnego.



Rozwiązania IT

Szeroki zakres inteligentnych i użytecznych narzędzi, które ułatwiają codzienną pracę i tworzenie zaawansowanych projektów:

- **CADvent** - pełny zestaw narzędzi do rysowania, wymiarowania, obliczania, kwantyfikacji i prezentacji kompletnej instalacji HVAC (program działa jako nakładka na program AutoCAD®),
- **lindQST.com** - platforma on-line do doboru i symulacji produktów Lindab Comfort,
- **DIMsilencer** - dobór tłumików akustycznych: okrągłych, prostokątnych, kolankowych, etc.
- **TEKNOSim** - precyzyjny program do symulacji klimatu w pomieszczeniu, służący do obliczania temperatur i bilansu cieplnego oraz doboru urządzeń chłodzących i grzewczych.



W sprawie zamówień prosimy o kontakt z Działem Handlowym Wentylacji Lindab Sp. z o.o.:

tel. +48 22 250 50 57

tel. +48 22 250 50 17

e-mail: kontakt@lindab.com

Zawory wentylacyjne Lindab Airy



Nadaj nowy wygląd swojemu salonowi, łazience lub sypialni, polepszając jednocześnie mikroklimat wewnątrz pomieszczeń. Lindab Airy to cienki, wydajny zawór powietrza o nieograniczonych możliwościach i najniższym poziomie dźwięku.

Wolisz czystą biel, wesoły rozbłysk koloru, lub połysk nierdzewnej stali? Niezależnie od preferowanego wyglądu, uzyskasz idealną harmonię mikroklimatu wnętrza i jego stylu.

Typ	Materiał / RAL	D [mm]		
		100	125	160
		Cena [EUR/szt.]		
Panel front	9003/9010	9,73	10,80	12,04
Korpus	9003/9010	21,61	23,39	26,86

Wybierz kształt:



OKRĄGŁY
AIRYFP ROUN



KWADRATOWY
AIRYFP SQUA



ŁUKOWATY
AIRYFP BOW



ELIPSOIDALNY
AIRYFP ELLI



PROSTOKĄTNY
AIRYFP RECT

Przykład zamówienia: AIRYFP BOW 125 RAL 9003 + AIRYB 125 RAL 9003.

Inne kolory na zapytanie ofertowe.

Ceny przeliczane na PLN w dniu sprzedaży wg kursów średnich NBP.

Nawiewniki liniowe

LDW



Typ	Cena [EUR/szt.]	
	Bez skrzynki	Ze skrzynką rozprężną
LDW	cena na zapytanie	

Nawiewniki szczelinowe

LD-xx



Typ nawiewnika	Cena [EUR/szt.]	
	Bez skrzynki	Ze skrzynką rozprężną
LD-13	cena na zapytanie	
LD-14		
LD-17		
LD-18		

Wysokoindukcyjny nawiewnik o zmiennej geometrii

KZ



Wymiary [mm]	Cena [EUR/szt.]		
	KZ	KZ-CT ze sterownikiem termostaticznym	KZ1 z mechanizmem do jednoczesnej regulacji wszystkimi topalkami
ø160 - ø800	cena na zapytanie		

Wysokoindukcyjny nawiewnik o stałej geometrii

KPZ



Wymiary [mm]	Cena [EUR/szt.]		
	KPZ z panelem kwadratowym	KPZ6 z łącznikiem kątowym z panelem 596x596	KPRZ z panelem okrągłym
ø125 - ø400	cena na zapytanie		

Wysokoindukcyjny anemostat dalekiego zasięgu dla głębokiego strumienia

KV



Wymiary [mm]	Cena [EUR/szt.]		
	KV	KV-CT z kontrolą termostatyczną	KV1 / KV2 z serwowmotorem (z silownikiem)
ø40 - ø230	cena na zapytanie		

Dysze dalekiego zasięgu • Ceiling diffusers

VŠ-5



	VŠ-5/R	VŠ-5/D/R VŠ-5/K/R	VŠ-5/E/R	VŠ-5/D/TR VŠ-5/K/TR	VŠ-5/E/TR
Wymiary [mm]	Cena [EUR/szt.]				
	RAL 9010 / C0	RAL 9010 / C0	RAL 9010 / C0	RAL 9010 / C0	RAL 9010 / C0
ø100 - ø400	cena na zapytanie				

Nawiewniki / wywiewniki

CRL



Wymiary [mm]	Cena [PLN/szt.]
ø100 - ø400	cena na zapytanie

Łącznik*

MBZ



* element wymagany do połączenia CRL z MBB.

Wymiary [mm]	Cena [PLN/szt.]
ø100 - ø400	cena na zapytanie

Nawiewniki / wywiewniki

LCA



Wymiary [mm]	Cena [PLN/szt.]
ø100 - ø400	cena na zapytanie

Nawiewniki / wywiewniki

LKA



Wymiary [mm]	Cena [PLN/szt.]
ø125 - ø400	cena na zapytanie

Nawiewniki / wywiewniki

LCP



Wymiary [mm]	Cena [PLN/szt.]
ø125 - ø315	cena na zapytanie

Nawiewniki / wywiewniki

LKP



Wymiary [mm]	Cena [PLN/szt.]
ø125 - ø315	cena na zapytanie

Płyta adaptacyjna

LM



Produkt	Cena [PLN/szt.]
LM	cena na zapytanie

Nawiewniki / wywiewniki

PCA



Wymiary [mm]	Cena [PLN/szt.]
ø100 - ø400	cena na zapytanie

Nawiewniki / wywiewniki

PKA



Wymiary [mm]	Cena [PLN/szt.]
ø125 - ø400	cena na zapytanie

Skrzynka rozprężna

MB



Wymiary [mm]	Cena [PLN/szt.]
ø100 - ø315	cena na zapytanie

Kratki na przewody okrągłe

RGS



Wymiary [mm]	Cena [PLN/szt.]						
	RGS-0	RGS-1	RGS-2	RGS-3	RGS-4	RGS-6	RGS-7
325 - 1225	cena na zapytanie						

RGS-0: pojedyncze łopatki; **RGS-1:** podwójne łopatki; **RGS-2:** pojedyncze łopatki, z przepustnicą wychylną; **RGS-3:** podwójne łopatki, z przepustnicą wychylną; **RGS-4:** pojedyncze łopatki, z przepustnicą przesuwaną; **RGS-6:** pojedyncze łopatki, z pochyloną przepustnicą przesuwaną; **RGS-7:** podwójne łopatki, z pochyloną przepustnicą przesuwaną;

Przewody tłumiące

AKUCOM



Średnica [mm]	Długość [mm]	Izolacja [mm]	Cena [PLN/szt.]
ø100 - ø315	600 / 1200	25	cena na zapytanie

Tłumiki elastyczne

FSA



Średnica [mm]	Długość [mm]	Cena [PLN/szt.]
ø100 - ø315	550 / 1100	cena na zapytanie

SR-Cutter

SRCS2



Cena [PLN/szt.] • Price [PLN/pc]

cena na zapytanie

Nożyce elektryczne

CSS



Cena [PLN/szt.] • Price [PLN/pc]

cena na zapytanie

Nożyce elektr. akumulatorowe

CSSB



Cena [PLN/szt.] • Price [PLN/pc]

cena na zapytanie

SR-Roller

SRR



Cena [PLN/szt.] • Price [PLN/pc]

cena na zapytanie

Tester szczelności • Leakage tester

LTEST

Kompletny zestaw do pomiaru szczelności w systemie wentylacyjnym. Urządzenie jest automatycznie regulowane do wybranego ciśnienia. Wszystko jest wbudowane w urządzenie. Urządzenie automatycznie oblicza nieszczelności oraz sprawdza, czy wybrana klasa szczelności została osiągnięta.

Cena [PLN/szt.] • Price [PLN/pc]

cena na zapytanie



Wybrane produkty Lindab ICS dostępne na zapytanie ofertowe

Nawiewniki sufitowe



RS14

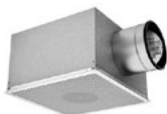

PS1



NS19



LCS

Nawiewniki przemysłowe



RCW



RCWB



FKD



HLD

Aluminiowe kratki wentylacyjne



AL-10-C



AD-21-C



AE-11-C



AG-10

Nawiewniki wyporowe



CBA



CKA



CBAL



CCU

Wybrane produkty Lindab ICS dostępne na zapytanie ofertowe

Dysze nawiewne



GTI

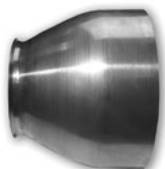

LAD



GD



KV

Belki chłodzące i panele grzewcze



Professor



Premax



Plexus



Atrium

Nawiewniki ściennie i zawory transferowe



DR24



NR19



OLR

Pełna oferta
produktów Lindab
dostępna
na stronie:
www.lindab.pl



Rura zwijana z blachy stalowej ocynkowanej - Circular duct (galvanized steel)

RZ

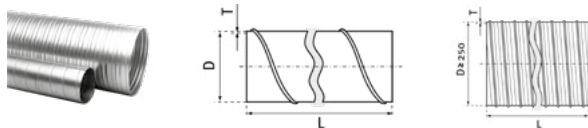

Rury zwijane z blachy stalowej ocynkowanej, wykonane w klasie ocynku Z200-Z275, minimalna masa powłoki obustronnie 200-275 g/m², zgodnie z PN-EN 10346.

Circular ducts made of zinc coated steel sheet, class Z200-Z275, min. mass of two-sided zinc coat 200-275 g/m² according to the PN-EN 10346.

øD [mm]	Grubość ścianki - Wall thickness [mm]							
	T=0,50		T=0,60		T=0,70		T=0,90	
	PLN / m	PLN / szt.	PLN / m	PLN / szt.	PLN / m	PLN / szt.	PLN / m	PLN / szt.
80	56,00	168,00						
100	68,00	204,00						
125	85,00	255,00						
140	94,00	282,00						
150	102,00	306,00						
160	107,00	321,00						
180	123,00	369,00						
200	135,00	405,00						
224	152,00	456,00						
250	169,00	507,00						
280	188,00	564,00						
300	201,00	603,00						
315	213,00	639,00						
355	297,00	891,00						
400	331,00	993,00						
450	379,00	1 137,00						
500			522,00	1 566,00				
560			598,00	1 794,00				
630			673,00	2 019,00				
710					769,00	2 307,00		
800					867,00	2 601,00		
900					1 341,00	4 023,00		
1000							1 425,00	4 275,00
1250							1 796,00	5 388,00

Niestandardowe grubości ścianki - cena na zapytanie ofertowe
Price for not standard wall thicknesses for enquiry.

Długość standardowa L: 3 m (do ø560) / 2,7 m (od ø630) - Standard lengths L: 3 m (≤ ø560) / 2,7 m (≥ ø630).

Długości niestandardowe: 2500≤L<3000 mm: dopłata - extra charge +5%, 1000≤L<2000 mm: dopłata - extra charge +20%,

• Non-standard lengths: 2000≤L<2500 mm: dopłata - extra charge +10%, L<1000 mm: dopłata - extra charge +30%.



Rura zwijana ze stali kwasoodpornej • Circular duct (stainless steel)

RZ-S



øD [mm]	Grubość blachy • Sheet thickness [mm]	Cena [EUR/szt.] • Price [EUR/pc]
80	0,5	63,69
100	0,5	78,32
112	0,5	94,60
125	0,5	97,57
140	0,5	114,18
150	0,5	123,97
160	0,5	131,23
180	0,5	147,29
200	0,5	160,05
224	0,5	181,39
250	0,5	196,02
280	0,5	262,90
300	0,5	256,19
315	0,5	289,96

øD [mm]	Grubość blachy • Sheet thickness [mm]	Cena [EUR/szt.] • Price [EUR/pc]
355	0,5	324,94
400	0,5	351,12
450	0,6	442,64
500	0,6	543,07
560	0,6	627,55
600	0,6	646,25
630	0,6	675,51
710	0,8	859,54
800	0,8	962,17
900	0,8	1 193,17
1000	0,8	1 319,89
1120	0,8	1 478,29
1250	0,8	1 669,03

UWAGA: długości standardowe L=3000 mm. Inne średnice na zapytanie ofertowe.
Możliwość wykonania rur o grubości blachy 0,8 mm.

ATTENTION: standard lengths are L=3000 mm. Price for other diameter for enquiry.

On individual demand ducts can be produced of 0,8mm thick material.



SPIRBOX - bezpieczny system transportu rur SPIRO® - Pipe transportation

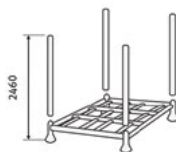
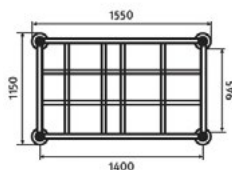

Kupując rury zwijane SPIRO® z dostawą w systemie SPIRBOX klient kupuje również kosz SPIRBOX (**950 zł netto** za każdy kosz SPIRBOX). Lindab odkupuje kosze SPIRBOX od klientów za tę samą cenę.

Ordering coil ducts in a SPIRBOX delivery system You are also purchasing SPIRBOX box (950 PLN per one SPIRBOX). Lindab buys the boxes back at the same price.

øD [mm]	Ilość rur (3 mb) w koszu SPIRBOX • Pipe quantity (3m) in a box [szt. • pc]	kosz SPIRBOX • SPIRBOX box
100	200	950 PLN
125	130	
150	94	
160	80	
200	48	
250	30	
315	20	



Mocowanie kanału • Duct support

MDR



Używane do przytwierdzenia kanału na jego złączeniach. W podstawie znajdują się otwory do montażu.

Used to fix ducts standing on joists. Is provided with fixing holes in the base.

øD [mm]	Cena [PLN/szt.] • Price [PLN/pc]
80	29,93
100	29,93
125	38,93
140	41,27
150	43,61
160	45,94
180	56,62
200	67,52
224	70,08
250	72,64

øD [mm]	Cena [PLN/szt.] • Price [PLN/pc]
280	80,20
300	87,99
315	91,11
355	103,23
400	115,25
450	134,05
500	152,84
560	197,90
630	242,73



Kolano tłoczone SAFE bez uszczelki • Pressed bend without gasket

B



	90°	60°	45°	30°	15°
øD [mm]	Cena [PLN/szt.] • Price [PLN/pc]				
80	46,05	78,43	37,04	40,05	64,41
100	46,83	55,73	37,04	40,05	55,73
125	58,29	62,07	43,95	46,95	62,63
150	80,65	112,46	59,63	64,41	83,66
160	84,77	117,14	63,18	66,07	73,19
180	110,57	142,95	78,31	83,66	99,34
200	125,26	141,17	83,54	92,33	95,77
250	208,02	x	135,16	x	x

Kolano tłoczone z uszczelką • Pressed bend with gasket

BL



	90°	60°	45°	30°	15°
øD [mm]	Cena [PLN/szt.] • Price [PLN/pc]				
80	64,41	95,56	56,40	58,07	81,98
100	69,30	73,42	56,51	58,07	73,42
125	82,43	81,98	65,40	64,85	80,20
150	103,01	134,94	76,20	85,43	104,34
160	110,24	138,50	86,32	88,77	95,56
180	128,26	162,52	89,22	104,57	132,60
200	148,18	166,75	104,34	116,13	121,02
250	223,59	x	152,29	x	x

Wykonanie z: blachy stalowej ocynkowanej - w klasie ocynku Z275, minimalna masa powłoki obustronnie 275 g/m², zgodnie z PN-EN 10346.

Completed out of: galvanized steel - in class Z275, min. mass of two-sided zinc coat 275 g/m² according to the PN-EN 10346.



Kolano krótkie nypłowe/nypłowo-mufowe 90° • 90° Short pressed bend

BFK(M)L

Kolano tłoczone, zgrzewane liniowo z krótkim promieniem, który ułatwia montaż w miejscach trudno dostępnych. • Used to fix ducts standing on joists. Is provided with fixing holes in the base.



øD [mm]	Cena [PLN/szt.] • Price [PLN/pc]	
	BFKL	BFKML
100	63,97	84,21
125	75,31	95,89
160	93,11	110,69

Kolano tłoczone bez uszczelki (stal kwasoodporna)

• Pressed bend without gasket (stainless steel)

B-S



øD [mm]	90°	45°
	Cena [PLN/szt.] • Price [PLN/pc]	
100	196,89	155,40
125	244,73	184,32
160	355,86	265,64
200	525,83	350,74

Kolano tłoczone z uszczelką (stal kwasoodporna)

• Pressed bend with gasket (stainless steel)

BL-S



øD [mm]	90°	45°
	Cena [PLN/szt.] • Price [PLN/pc]	
100	291,11	237,50
125	346,29	274,65
160	462,87	362,31
200	622,27	438,18

Wykonanie z: blachy stalowej ocynkowanej - w klasie ocynku Z275, minimalna masa powłoki obustronnie 275 g/m², zgodnie z PN-EN 10346; ze stali kwasoodpornej - 1.4301 EN 10088.

Completed out of: galvanized steel - in class Z275, min. mass of two-sided zinc coat 275 g/m² according to the PN-EN 10346; stainless steel - 1.4301 EN 10088.



Kolano segmentowe bez uszczelki • Segmented bend without gasket

BFE



	90°	60°	45°	30°	15°
øD [mm]	Cena [PLN/szt.] • Price [PLN/pc]				
224	85,55	75,20	66,19	50,62	45,61
250	87,21	76,76	67,52	51,61	46,49
315	112,91	91,99	88,11	61,52	55,51
355	159,41	141,38	114,13	83,76	75,31
400	189,44	167,97	135,60	99,57	89,55
450	243,17	214,02	161,41	123,14	110,80
500	291,22	262,97	198,12	161,97	145,72
630	489,23	449,41	371,88	268,32	241,39
710	807,83	687,80	513,82	369,09	316,15
800	910,39	801,15	579,12	434,28	390,90
1000	1 522,88	1 339,89	871,34	629,39	566,44

Na zamówienie • On request: ø280, ø300, ø350, ø560, ø900, ø1120, ø1250.

Kolano segmentowe bez uszczelki (stal kwasoodporna)

• Segmented bend without gasket (stainless steel)

BFE-S



	90°	45°
øD [mm]	Cena [PLN/szt.] • Price [PLN/pc]	
250	366,31	283,55
315	474,33	369,65
355	669,77	479,44
400	795,81	569,66
450	1 021,41	678,12
500	1 222,97	831,85
630	2 054,94	1 562,04

Wykonanie z: blachy stalowej ocynkowanej - w klasie ocynku Z275, minimalna masa powłoki obustronnie 275 g/m², zgodnie z PN-EN 10346; ze stali kwasoodpornej - 1.4301 EN 10088.

Completed out of: galvanized steel - in class Z275, min. mass of two-sided zinc coat 275 g/m² according to the PN-EN 10346; stainless steel - 1.4301 EN 10088.



Kolano segmentowe z uszczelką • Segmented bend with gasket

BFL



	90°	60°	45°	30°	15°
øD [mm]	Cena [PLN/szt.] • Price [PLN/pc]				
224	112,46	110,02	109,90	98,90	98,45
250	112,46	110,02	109,90	98,90	98,45
315	148,73	132,38	132,15	118,92	118,36
355	195,67	174,10	173,87	156,51	155,84
400	242,61	215,81	215,58	194,12	193,22
450	309,58	275,43	275,10	247,62	246,51
500	380,55	338,50	322,05	304,35	303,02
630	673,34	639,74	482,11	455,75	453,52
710	994,26	944,43	712,04	672,78	669,66
800	1 104,61	1 049,44	791,14	747,53	744,09
1000	1 776,84	1 687,95	1 272,48	1 202,40	1 196,72

Na zamówienie • On request: ø280, ø300, ø350, ø560, ø900, ø1120, ø1250.

Wykonanie z: blachy stalowej ocynkowanej - w klasie ocynku Z275, minimalna masa powłoki obustronnie 275 g/m², zgodnie z PN-EN 10346.

Completed out of: galvanized steel - in class Z275, min. mass of two-sided zinc coat 275 g/m² according to the PN-EN 10346.



Redukcja tłoczona SAFE bez uszczelki • Pressed reducer without gasket

RC



øD [mm]	Cena [PLN/szt.] • Price [PLN/pc]										
	øB [mm]										
	100	125	150	160	180	200	224	250	300	315	
80	32,37	38,26	x	39,50	x	x	x	x	x	x	x
100	x	38,26	38,60	39,82	51,84	53,29	x	x	x	x	x
125	x	x	38,60	38,83	51,84	53,29	x	69,75	x	x	x
150	x	x	x	42,50	51,84	53,29	73,98	69,75	x	x	x
160	x	x	x	x	51,84	50,84	73,98	69,75	x	x	93,21
180	x	x	x	x	x	50,84	x	69,75	x	x	x
200	x	x	x	x	x	x	63,63	69,75	95,44	93,21	x
224	x	x	x	x	x	x	x	69,75	x	x	x
250	x	x	x	x	x	x	x	x	92,77	92,56	x

Redukcja tłoczona z uszczelką • Pressed reducer with gasket

RCPL

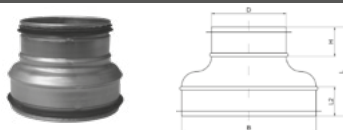

øD [mm]	Cena [PLN/szt.] • Price [PLN/pc]										
	øB [mm]										
	100	125	150	160	180	200	224	250	300	315	355
80	51,28	58,07	x	60,85	x	x	x	x	x	x	x
100	x	58,07	67,41	60,85	81,54	79,21	x	x	x	x	x
125	x	x	67,41	60,85	81,54	79,21	x	x	x	x	x
150	x	x	x	x	79,76	77,43	73,98	x	x	x	x
160	x	x	x	x	79,76	77,43	106,12	103,12	x	128,93	x
200	x	x	x	x	x	x	106,12	104,79	132,48	132,48	x
224	x	x	x	x	x	x	x	104,79	x	x	x
250	x	x	x	x	x	x	x	x	132,48	135,60	244,84
315	x	x	x	x	x	x	x	x	x	x	233,71

Wykonanie z: blachy stalowej ocynkowanej - w klasie ocynku Z275, minimalna masa powłoki obustronnie 275 g/m², zgodnie z PN-EN 10346.

Completed out of: galvanized steel - in class Z275, min. mass of two-sided zinc coat 275 g/m² according to the PN-EN 10346.



Redukcja tłoczona mufowo-nyplowa SAFE bez uszczelki

• Pressed male-female reducer without gasket

RCF

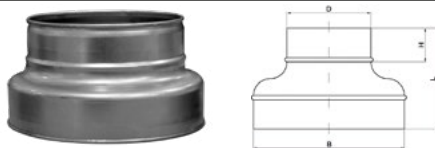

øD [mm]	Cena [PLN/szt.] • Price [PLN/pc]						
	øB [mm]						
	100	125	150	160	200	250	315
80	29,26	38,26	x	x	x	x	x
100	x	32,70	45,72	39,71	48,50	x	x
125	x	x	35,82	40,38	47,39	x	x
150	x	x	x	x	58,29	x	x
160	x	x	x	x	49,51	69,97	91,66
200	x	x	x	x	x	69,97	91,66
250	x	x	x	x	x	x	91,66

Redukcja tłoczona mufowo-nyplowa z uszczelką

• Pressed male-female reducer with gasket

RCFPL



øD [mm]	Cena [PLN/szt.] • Price [PLN/pc]						
	øB [mm]						
	100	125	150	160	200	250	315
80	37,27	50,94	x	x	x	x	x
100	x	41,49	58,29	48,50	57,62	x	x
125	x	x	58,29	49,83	57,29	x	x
150	x	x	x	x	65,63	x	x
160	x	x	x	x	59,29	79,42	104,67
200	x	x	x	x	x	79,42	104,67
250	x	x	x	x	x	x	104,67

Wykonanie z: blachy stalowej ocynkowanej - w klasie ocynku Z275, minimalna masa powłoki obustronnie 275 g/m², zgodnie z PN-EN 10346.

Completed out of: galvanized steel - in class Z275, min. mass of two-sided zinc coat 275 g/m² according to the PN-EN 10346.



Redukcja symetryczna bez uszczelki

• Symmetric hand made reducer without gasket

RCLE



ød [mm]	Cena [PLN/szt.] • Price [PLN/pc]				
	øD [mm]				
	400	500	630	800	1000
160	99,34	140,27	x	x	x
200	99,34	136,93	206,24	x	x
250	99,34	133,49	195,11	x	x
315	99,34	130,04	187,11	313,92	x
355	99,34	126,59	187,11	301,90	x
400	x	126,59	183,00	293,90	492,12
450	x	126,59	183,00	293,90	492,12
500	x	x	179,32	285,78	451,19
630	x	x	x	281,77	410,14
800	x	x	x	x	369,21

Redukcja symetryczna z uszczelką • Symmetric hand made reducer with gasket

RCLL



ød [mm]	Cena [PLN/szt.] • Price [PLN/pc]				
	øD [mm]				
	400	500	630	800	1000
160	149,06	204,79	x	x	x
200	149,06	201,91	294,89	x	x
250	149,06	198,89	285,55	x	x
315	149,06	196,34	282,21	406,91	x
355	149,06	193,56	278,99	396,58	x
400	x	193,45	275,88	389,67	551,64
450	x	193,45	275,65	389,67	551,64
500	x	x	272,65	382,77	520,71
630	x	x	x	379,22	517,16
800	x	x	x	x	482,78

Wykonanie z: blachy stalowej ocynkowanej - w klasie ocynku Z275, minimalna masa powłoki obustronnie 275 g/m², zgodnie z PN-EN 10346.

Completed out of: galvanized steel - in class Z275, min. mass of two-sided zinc coat 275 g/m² according to the PN-EN 10346.



Redukcja niesymetryczna bez uszczelki

• Eccentric hand made reducer without gasket

RLE



ød [mm]	Cena [PLN/szt.] • Price [PLN/pc]				
	øD [mm]				
	400	500	630	800	1000
160	123,70	174,75	x	x	x
200	123,70	170,42	285,34	x	x
250	123,70	166,19	269,87	x	x
315	123,70	161,97	258,85	383,78	x
355	123,70	157,73	258,85	369,09	x
400	x	155,74	253,18	359,31	601,81
450	x	x	253,18	359,31	601,81
500	x	x	247,96	349,40	551,52
630	x	x	x	344,40	501,47
800	x	x	x	x	451,30

Redukcja niesymetryczna z uszczelką

• Eccentric hand made reducer with gasket

RLL



ød [mm]	Cena [PLN/szt.] • Price [PLN/pc]				
	øD [mm]				
	400	500	630	800	1000
160	181,88	254,97	x	x	x
200	181,88	251,51	370,87	x	x
250	181,88	247,62	359,08	x	x
315	181,88	244,50	354,86	497,47	x
355	181,88	240,95	350,85	484,78	x
400	x	239,50	347,07	476,33	687,36
450	x	x	346,52	476,33	687,36
500	x	x	342,73	467,88	648,76
630	x	x	x	463,76	644,41
800	x	x	x	x	601,47

Wykonanie z: blachy stalowej ocynkowanej - w klasie ocynku Z275, minimalna masa powłoki obustronnie 275 g/m², zgodnie z PN-EN 10346.

Completed out of: galvanized steel - in class Z275, min. mass of two-sided zinc coat 275 g/m² according to the PN-EN 10346.



Redukcja symetryczna bez uszczelki (stal kwasoodporna)

• Symmetric hand made reducer without gasket (stainless steel)

RCLE-S



ød [mm]	Cena [PLN/szt.] • Price [PLN/pc]							
	øD [mm]							
	125	160	200	250	315	400	500	630
100	160,63	167,09	223,26	x	x	x	x	x
125	x	162,41	223,26	292,12	x	x	x	x
160	x	x	213,03	292,12	390,68	417,26	589,24	x
200	x	x	x	292,12	390,68	417,26	575,00	866,33
250	x	x	x	x	387,56	417,26	560,42	819,17
315	x	x	x	x	x	417,26	546,19	786,13
400	x	x	x	x	x	x	531,73	768,67
450	x	x	x	x	x	x	531,73	768,67
500	x	x	x	x	x	x	x	752,99

Trójnik symetryczny bez uszczelki • T-piece without gasket

TCP(E)

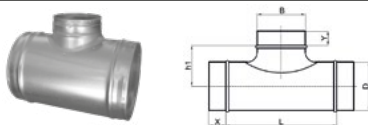

øB [mm]	Cena [PLN/szt.] • Price [PLN/pc]									
	øD [mm]									
	100	125	160	200	250	315	400	500	630	800
80	43,28	44,94	46,61	50,94	x	x	x	x	x	x
100	43,72	45,94	47,39	58,29	67,08	84,10	x	x	x	x
125	x	47,94	51,61	60,63	71,42	88,21	121,25	x	x	x
160	x	x	73,86	71,42	82,43	92,10	126,26	161,07	199,35	316,15
200	x	x	x	78,87	95,22	111,91	154,18	188,10	199,35	316,15
250	x	x	x	x	118,36	137,60	173,87	215,81	225,27	341,95
315	x	x	x	x	x	187,44	210,47	276,99	285,55	380,67
400	x	x	x	x	x	x	281,33	343,84	375,55	412,93
500	x	x	x	x	x	x	x	431,72	446,30	470,99
630	x	x	x	x	x	x	x	x	579,23	616,04

Wykonanie z: blachy stalowej ocynkowanej - w klasie ocynku Z275, minimalna masa powłoki obustronnie 275 g/m², zgodnie z PN-EN 10346; ze stali kwasoodpornej - 1.4301 EN 10088.

Completed out of: galvanized steel - in class Z275, min. mass of two-sided zinc coat 275 g/m² according to the PN-EN 10346; stainless steel - 1.4301 EN 10088.

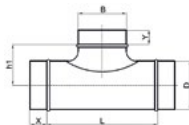
Trójnik symetryczny z uszczelką • T-piece with gasket
TCPL

øB [mm]								
	160	200	250	315	400	500	630	800
80	76,98	108,68	x	x	x	x	x	x
100	x	84,54	104,23	132,94	x	x	x	x
125	x	94,78	108,68	137,39	234,05	x	x	x
160	x	x	124,82	163,97	234,05	268,53	284,88	451,53
200	x	x	144,06	190,66	234,05	268,53	284,88	451,53
250	x	x	x	234,94	292,56	308,36	321,93	488,34
315	x	x	x	x	370,66	395,57	407,92	543,74
400	x	x	x	x	433,94	491,13	536,40	589,68
500	x	x	x	x	x	616,71	637,51	672,67
630	x	x	x	x	x	x	827,40	880,02

Trójnik symetryczny bez uszczelki (stal kwasoodporną)

• T-piece without gasket (stainless steel)

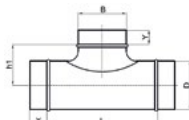
TCPE-S

øB [mm]	Cena [PLN/szt.] • Price [PLN/pc]								
	øD [mm]								
	100	125	160	200	250	315	400	500	630
100	195,89	205,69	208,90	256,41	295,01	370,09	x	x	x
125	x	214,69	231,38	266,53	313,80	387,89	509,37	x	x
160	x	x	330,94	319,59	362,64	405,36	530,17	676,45	837,53
200	x	x	x	353,41	426,72	492,35	647,75	789,80	837,53
250	x	x	x	x	530,17	616,60	730,30	906,71	946,54
315	x	x	x	x	x	839,97	883,92	1 163,24	1 199,17
400	x	x	x	x	x	x	1 181,60	1 444,34	1 577,28
500	x	x	x	x	x	x	x	1 813,32	1 874,50
630	x	x	x	x	x	x	x	x	2 432,82

Średnice na zamówienie • On request: ø140, ø224, ø280, ø300, ø350, ø355, ø560, ø710, ø900.

 Wykonanie z: blachy stalowej ocynkowanej - w klasie ocynku Z275, minimalna masa powłoki obustronnie 275 g/m², zgodnie z PN-EN 10346; ze stali kwasoodpornej - 1.4301 EN 10088.

 Completed out of: galvanized steel - in class Z275, min. mass of two-sided zinc coat 275 g/m² according to the PN-EN 10346; stainless steel - 1.4301 EN 10088.



Trójnik symetryczny tłoczony SAFE bez uszczelki

• Pressed T-piece without gasket

TSHF



ød ₃ [mm]	Cena [PLN/szt.] • Price [PLN/pc]					
	ød ₁ [mm]					
	100	125	160	200	250	315
80	44,60	50,28	x	x	x	x
100	48,39	52,73	58,41	x	x	x
125	x	58,96	66,64	x	x	x
160	x	x	77,76	85,43	x	x
200	x	x	x	97,89	x	x
250	x	x	x	x	164,41	x
315	x	x	x	x	x	229,72

Trójnik symetryczny tłoczony z uszczelką • Pressed T-piece with gasket

TSHFL

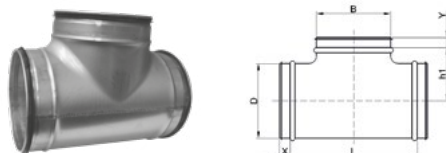

ød ₃ [mm]	Cena [PLN/szt.] • Price [PLN/pc]					
	ød ₁ [mm]					
	100	125	160	200	250	315
80	69,75	84,77	x	x	x	x
100	75,31	94,89	84,77	x	x	x
125	x	111,13	94,89	x	x	x
160	x	x	111,13	124,25	x	x
200	x	x	x	138,05	x	x
250	x	x	x	x	222,15	x
315	x	x	x	x	x	300,01



Trójnik z odejściem pod kątem 45° bez uszczelki • 45° T-piece without gasket

TVE 45

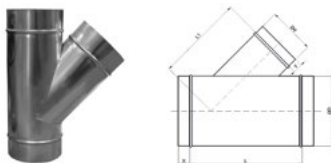

ød [mm]	Cena [PLN/szt.] • Price [PLN/pc]									
	øD [mm]									
	100	125	150	160	200	250	315	400	500	630
100	88,32	96,00	110,46	114,80	127,48	139,05	176,54	x	x	x
125	x	110,35	128,93	131,37	134,05	144,95	181,88	241,16	x	x
150	x	x	138,82	138,82	145,17	152,40	188,77	256,63	x	x
160	x	x	x	147,40	154,18	158,97	197,46	271,09	x	x
200	x	x	x	x	165,97	176,87	225,15	292,23	338,84	427,05
250	x	x	x	x	x	202,46	244,39	315,14	377,77	453,42
315	x	x	x	x	x	x	299,46	394,02	418,49	548,41
400	x	x	x	x	x	x	x	433,17	532,61	584,24
500	x	x	x	x	x	x	x	x	764,11	825,17
630	x	x	x	x	x	x	x	x	x	1 096,16

Trójnik z odejściem pod kątem 45° z uszczelką • 45° T-piece with gasket

TVL 45

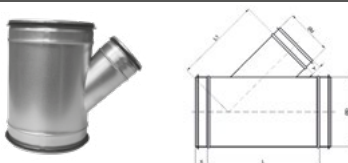

ød [mm]	Cena [PLN/szt.] • Price [PLN/pc]									
	øD [mm]									
	100	125	150	160	200	250	315	400	500	630
100	110,46	120,03	138,16	143,50	159,18	173,64	220,48	x	x	x
125	x	137,94	161,19	164,30	167,64	181,32	227,26	301,46	x	x
150	x	x	173,53	173,53	181,55	190,66	235,94	320,71	x	x
160	x	x	x	184,22	192,78	198,68	246,84	338,84	x	x
200	x	x	x	x	207,58	221,03	281,55	365,31	423,49	533,84
250	x	x	x	x	x	252,96	305,47	394,02	472,22	566,88
315	x	x	x	x	x	x	374,33	492,46	523,05	685,35
400	x	x	x	x	x	x	x	541,51	665,78	730,30
500	x	x	x	x	x	x	x	x	955,22	1 031,53
630	x	x	x	x	x	x	x	x	x	1 370,37



Trójnik orłowy bez uszczelki - *Twin bend without gasket*

YVE

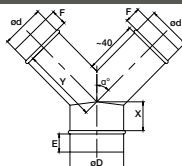

δd [mm]	Cena [PLN/szt.] • Price [PLN/pc]					
	δD [mm]					
	100	125	150	160	200	250
$\alpha=45^\circ$						
100	51,95	61,41	70,31	78,43	91,99	113,36
125	x	57,07	75,64	80,98	99,11	127,59
160	x	x	79,76	92,56	107,46	136,93
200	x	x	x	83,20	120,92	155,96
250	x	x	x	x	116,91	162,97
315	x	x	x	x	x	168,75
$\alpha=90^\circ$						
100	47,16	55,85	63,97	71,30	x	x
125	x	51,95	68,74	73,65	90,21	x
160	x	x	x	84,10	97,66	x
200	x	x	x	x	109,90	141,72
250	x	x	x	x	x	148,06

Wykonanie z: blachy stalowej ocynkowanej - w klasie ocynku Z275, minimalna masa powłoki obustronnie 275 g/m², zgodnie z PN-EN 10346.

Completed out of: galvanized steel - in class Z275, min. mass of two-sided zinc coat 275 g/m² according to the PN-EN 10346.



Trójnik orłowy z uszczelką - *Twin bend with gasket*

YVL

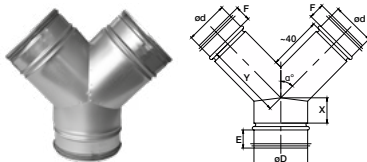

ød [mm]	Cena [PLN/szt.] • Price [PLN/pc]					
	øD [mm]					
	100	125	150	160	200	250
α=45°						
100	78,75	93,00	106,56	118,80	139,49	171,75
125	x	86,54	114,69	122,70	150,17	193,11
160	x	x	120,92	140,16	162,75	207,47
200	x	x	x	125,93	183,10	236,06
250	x	x	x	x	177,10	246,73
315	x	x	x	x	x	255,63
α=90°						
100	71,53	84,54	96,78	107,90	126,71	x
125	x	78,75	104,23	111,57	136,49	x
160	x	x	x	127,48	147,84	x
200	x	x	x	x	166,42	214,59
250	x	x	x	x	x	224,37

Wykonanie z: blachy stalowej ocynkowanej - w klasie ocynku Z275, minimalna masa powłoki obustronnie 275 g/m², zgodnie z PN-EN 10346.

Completed out of: galvanized steel - in class Z275, min. mass of two-sided zinc coat 275 g/m² according to the PN-EN 10346.



Sztucer siodłowy SAFE bez uszczelki - Collar saddle without gasket

PS / PSE



øD1 [mm]	Cena [PLN/szt.] • Price [PLN/pc]									
	øD [mm]									
	80	100	125	150	160	200	250	315	400	500
80	29,03	29,03	29,03	x	29,03	29,03	29,03	x	x	x
100	x	29,48	29,48	x	29,48	29,48	29,48	29,48	52,06	52,06
125	x	x	36,94	x	36,94	36,94	36,94	36,94	x	36,94
150	x	x	x	49,95	x	49,95	49,95	49,95	x	x
160	x	x	x	x	52,73	52,73	52,73	52,73	52,73	70,52
200	x	x	x	x	x	70,52	70,52	70,52	70,52	x
250	x	x	x	x	x	x	100,56	88,99	85,32	x
315	x	x	x	x	x	x	x	140,72	122,70	x

Sztucer siodłowy z uszczelką - Collar saddle with gasket

PSL

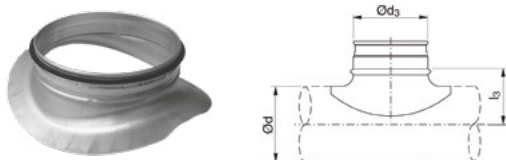

øD1 [mm]	Cena [PLN/szt.] • Price [PLN/pc]									
	øD [mm]									
	80	100	125	150	160	200	250	315	400	500
80	38,60	38,60	38,60	x	38,60	38,60	38,60	x	x	x
100	x	41,49	x	x	41,49	41,49	41,49	41,49	57,51	41,49
125	x	x	47,61	x	47,61	47,61	47,61	47,61	x	47,61
150	x	x	x	57,51	x	57,51	57,51	57,51	x	x
160	x	x	x	x	63,97	63,97	63,97	63,97	63,97	80,98
200	x	x	x	x	x	83,99	80,20	80,20	77,09	x
250	x	x	x	x	x	x	112,24	102,90	99,89	x
315	x	x	x	x	x	x	x	147,28	132,82	x

Wykonanie z: blachy stalowej ocynkowanej - w klasie ocynku Z275, minimalna masa powłoki obustronnie 275 g/m², zgodnie z PN-EN 10346.

Completed out of: galvanized steel - in class Z275, min. mass of two-sided zinc coat 275 g/m² according to the PN-EN 10346.



Sztucer z siatką • Angle take-off with mesh 45°

AVE



øD [mm]	Op. ^{*)}	Cena [PLN/ szt.] • Price [PLN/pc]	øD [mm]	Op. ^{*)}	Cena [PLN/ szt.] • Price [PLN/pc]	øD [mm]	Op. ^{*)}	Cena [PLN/ szt.] • Price [PLN/pc]
100	65	76,86	250	30	120,70	450	9	234,94
125	50	79,54	315	28	142,83	500	8	280,99
150	30	91,55	355	24	157,18	560		381,78
160	60	91,99	400	15	186,21	630		430,83
200	50	102,78						

*) Ilość [szt./opak.] • Quantity [pcs/pack.]

Sztucer, nakładka na kanał prostokątny • Flat shoes

FBE



øD [mm]	Cena [PLN/szt.] • Price [PLN/pc]	øD [mm]	Cena [PLN/szt.] • Price [PLN/pc]	øD [mm]	Cena [PLN/szt.] • Price [PLN/pc]
80	49,28	200	85,65	355	199,56
100	49,51	224	92,33	400	257,53
125	49,51	250	98,33	450	314,37
140	55,07	280	113,02	500	366,87
150	60,51	300	143,39	560	440,40
160	61,52	315	161,97	630	528,39
180	73,65				

Sztucer, nakładka na kanał okrągły • Curved boot

CBE

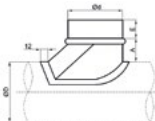

øD1 [mm]	Cena [PLN/szt.] • Price [PLN/pc]											
	øD [mm]											
	100	125	150	160	200	250	300	315	355	400	450	500
100	52,06	52,06	63,63	64,85	90,21	103,45	151,06	170,53	210,14	271,09	330,94	386,23
125	x	52,06	63,63	64,85	90,21	103,45	151,06	170,53	210,14	271,09	330,94	386,23
150	x	x	63,63	64,85	90,21	103,45	151,06	170,53	210,14	271,09	330,94	386,23
160	x	x	x	64,85	90,21	103,45	151,06	170,53	210,14	271,09	x	386,23
200	x	x	x	x	90,21	103,45	151,06	170,53	210,14	271,09	330,94	386,23
224	x	x	x	x	x	103,45	151,06	x	x	x	x	x
250	x	x	x	x	x	103,45	151,06	170,53	210,14	271,09	330,94	386,23
300	x	x	x	x	x	x	151,06	170,53	210,14	271,09	330,94	386,23
315	x	x	x	x	x	x	x	170,53	210,14	271,09	330,94	386,23

Wykonanie z: blachy stalowej ocynkowanej - w klasie ocynku Z275, minimalna masa powłoki obustronnie 275 g/m², zgodnie z PN-EN 10346.

Completed out of: galvanized steel - in class Z275, min. mass of two-sided zinc coat 275 g/m² according to the PN-EN 10346.



Łącznik nypłowy z uszczelką • Male connector with gasket

SSST



øD [mm]	Cena [PLN/szt.] • Price [PLN/pc]
80	11,00
100	10,00
125	11,00
140	12,00
150	12,00
160	13,00
180	14,00
200	14,00
224	17,00
250	17,00
280	21,00
300	24,00
315	24,00

øD [mm]	Cena [PLN/szt.] • Price [PLN/pc]
350	35,00
355	35,00
400	40,00
450	45,00
500	50,00
560	55,00
600	90,00
630	95,00
710	102,00
800	125,00
900	145,00
1000	180,00
1250	250,00

Wykonanie z: blachy stalowej ocynkowanej - w klasie ocynku Z275, minimalna masa powłoki obustronnie 275 g/m², zgodnie z PN-EN 10346.

Completed out of: galvanized steel - in class Z275, min. mass of two-sided zinc coat 275 g/m² according to the PN-EN 10346.



Nyple teleskopowy • Telescopic male coupling

SNPL



L [mm]	150	300	500
øD [mm]	Cena [PLN/szt.] • Price [PLN/pc]		
80	55,00	78,00	109,00
100	55,00	78,00	109,00
125	57,00	80,00	112,00
140	59,00	82,00	115,00
150	59,00	83,00	116,00
160	60,00	84,00	118,00
180	68,00	95,00	133,00
200	78,00	109,00	152,00
224	85,00	119,00	166,00
250	92,00	129,00	181,00
280	112,00	156,00	219,00
300	124,00	174,00	244,00
315	134,00	188,00	263,00
355	155,00	217,00	304,00
400	192,00	269,00	376,00
450	200,00	280,00	391,00
500	207,00	290,00	407,00
560	265,00	371,00	520,00
630	323,00	452,00	633,00



Nyple bez uszczelki • Male coupling without gasket

NP / NPE



øD [mm]	Op. ¹⁾ NP/NPE		Cena [PLN/szt.] • Price [PLN/pc]
80		70	12,24
100	90	112	12,24
125	60	72	12,24
150		50	12,24
160	60	70	12,91
180		60	14,23
200	40	54	15,68
224		45	17,13
250	55	72	18,68

øD [mm]	Op. ¹⁾ NP/NPE		Cena [PLN/szt.] • Price [PLN/pc]
315	36	46	25,59
355		30	27,48
400		30	34,38
500		24	48,84
630		16	68,30
710		15	94,45
800		10	120,70
1000			187,44
1250			250,06

Nyple z uszczelką • Male coupling with gasket

NPL

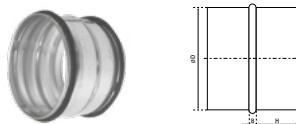

øD [mm]	Op. ¹⁾	Cena [PLN/szt.] • Price [PLN/pc]
80	70	27,70
100	90	27,70
125	60	27,70
150	45	27,70
160	60	30,03
180	50	33,93
200	40	38,93
224	30	42,50
250	55	46,05

øD [mm]	Op. ¹⁾	Cena [PLN/szt.] • Price [PLN/pc]
315	36	67,08
355	30	77,53
400	20	96,00
500	24	103,68
630	16	161,52
710	15	178,43
800	10	195,45
1000		314,37
1250		424,94

¹⁾ Ilość [szt./opak.] • Quantity [pcs/pack.]

Wykonanie z: blachy stalowej ocynkowanej - w klasie ocynku Z275, minimalna masa powłoki obustronnie 275 g/m², zgodnie z PN-EN 10346.

Completed out of: galvanized steel - in class Z275, min. mass of two-sided zinc coat 275 g/m² according to the PN-EN 10346.



Mufa • Female coupling

MF / MFE**)

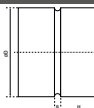

øD [mm]	Op. ¹⁾ MF/MFE		Cena [PLN/szt.] • Price [PLN/pc]
80	80	70	12,24
100	100	112	12,24
125	60	72	12,24
150	70	50	12,24
160	60	70	12,91
180	50	60	14,23
200	35	54	15,68
224	30	45	17,13
250	18	72	18,68

øD [mm]	Op. ¹⁾ MF/MFE		Cena [PLN/szt.] • Price [PLN/pc]
315		46	25,59
355		30	27,48
400		30	34,38
500		24	48,84
630		16	68,30
710		15	94,45
800		10	120,70
1000			187,44
1250			250,06

Nypel bez uszczelki i mufa ze stali kwasoodpornej • Male coupling without gasket and female coupling (stainless steel)

NPE-S / MFE-S

NPE-S



MFE-S

øD [mm]	Cena [PLN/szt.] • Price [PLN/pc]
100	49,51
125	49,51
160	49,51
200	60,51
250	66,19
315	86,88
355	118,58
400	148,39
500	211,25
630	295,56

øD [mm]	Cena [PLN/szt.] • Price [PLN/pc]
100	49,51
125	49,51
160	49,51
200	60,51
250	66,19
315	86,88
355	118,58
400	148,39
500	211,25
630	295,56

¹⁾ Ilość [szt./opak.] • Quantity [pcs/pack.]

²⁾ Dla średnic powyżej ø250 - wykonanie tylko MFE • for sizes above ø250 - MFE execution only

Wykonanie z: blachy stalowej ocynkowanej - w klasie ocynku Z275, minimalna masa powłoki obustronnie 275 g/m², zgodnie z PN-EN 10346; ze stali kwasoodpornej - 1.4301 EN 10088.

Completed out of: galvanized steel - in class Z275, min. mass of two-sided zinc coat 275 g/m² according to the PN-EN 10346; stainless steel - 1.4301 EN 10088.



Zaślepka przewodu • Duct end cap

ES



øD [mm]	Op. ¹⁾	Cena [PLN/szt.] • Price [PLN/pc]
80	150	11,57
100	100	15,24
125	70	16,24
140	65	19,92
150	50	18,03

øD [mm]	Op. ¹⁾	Cena [PLN/szt.] • Price [PLN/pc]
160	50	18,03
180	40	20,69
200	30	20,69
224	30	30,03
250	20	30,37

øD [mm]	Op. ¹⁾	Cena [PLN/szt.] • Price [PLN/pc]
300	25	45,72
315	20	48,50
355	15	62,07
400	15	71,53

Zaślepka przewodu z uszczelką • Duct end cap with gasket

ESL



øD [mm]	Op. ¹⁾	Cena [PLN/szt.] • Price [PLN/pc]
80	80	31,59
100	110	31,59
125	72	32,59
150	50	33,37

øD [mm]	Op. ¹⁾	Cena [PLN/szt.] • Price [PLN/pc]
160	40	34,04
180	30	39,04
200	50	41,39
224		130,04

øD [mm]	Op. ¹⁾	Cena [PLN/szt.] • Price [PLN/pc]
250	25	64,52
315	16	87,21
355		101,00
400		129,37

Zaślepka przewodu z uszczelką i rączką • Duct end cap with gasket and handle

ESLH



øD [mm]	Op. ¹⁾	Cena [PLN/szt.] • Price [PLN/pc]
80	80	42,94
100	110	42,94
125	72	44,27
140		79,32
150	50	45,06

øD [mm]	Op. ¹⁾	Cena [PLN/szt.] • Price [PLN/pc]
160	40	45,61
180	30	50,28
200	50	52,62
224		112,80
250	25	74,42

øD [mm]	Op. ¹⁾	Cena [PLN/szt.] • Price [PLN/pc]
280		157,96
300		157,96
315	16	96,55
355		109,46
400		136,83

¹⁾ Ilość [szt./opak.] • Quantity [pcs./pack.]

Wykonanie z: blachy stalowej ocynkowanej - w klasie ocynku Z275, minimalna masa powłoki obustronnie 275 g/m², zgodnie z PN-EN 10346.

Completed out of: galvanized steel - in class Z275, min. mass of two-sided zinc coat 275 g/m² according to the PN-EN 10346.



Zaślepka kształtki • Fitting end cap

EPF



øD [mm]	Op. ¹⁾	Cena [PLN/szt.] • Price [PLN/pc]
80	75	19,47
100	55	20,25
125	80	25,14
150	55	27,58
160	45	27,81
180	40	30,70
200	40	32,82
250	30	44,39

øD [mm]	Op. ¹⁾	Cena [PLN/szt.] • Price [PLN/pc]
315	22	61,07
355		84,10
400	12	89,10
500		125,59
630		147,28
800		228,27
1000		309,14

Zaślepka kształtki z rączką • Fitting end cap with handle

EPFH



øD [mm]	Op. ¹⁾	Cena [PLN/szt.] • Price [PLN/pc]
80	75	29,70
100	55	29,70
125	80	34,82
150	55	37,04
160	45	39,94
180	40	44,50

øD [mm]	Op. ¹⁾	Cena [PLN/szt.] • Price [PLN/pc]
200	40	46,28
250	30	57,51
315	22	75,75
355		89,10
400	12	98,00

¹⁾ Ilość [szt./opak.] • Quantity [pcs/pack.]

Wykonanie z: blachy stalowej ocynkowanej - w klasie ocynku Z275, minimalna masa powłoki obustronnie 275 g/m², zgodnie z PN-EN 10346.

Completed out of: galvanized steel - in class Z275, min. mass of two-sided zinc coat 275 g/m² according to the PN-EN 10346.



Sztucer cylindryczny prosty bez uszczelki • Flat take-off without gasket

IL(E)



øD [mm]	Op. ¹⁾	Cena [PLN/szt.] • Price [PLN/pc]
ILE 80	100	11,46
IL 100	150	12,01
IL 125	100	12,01
ILE 150	100	12,01
IL 160	100	12,68
ILE 180	50	14,13
IL 200	60	15,47
IL 250	40	20,36

øD [mm]	Op. ¹⁾	Cena [PLN/szt.] • Price [PLN/pc]
IL 315	30	27,70
ILE 355	28	30,26
ILE 400	35	35,05
ILE 500	60	47,61
ILE 630	40	70,19
ILE 800		119,80
ILE 1000		151,29

Sztucer cylindryczny prosty z uszczelką • Flat take-off with gasket

ILL



øD [mm]	Op. ¹⁾	Cena [PLN/szt.] • Price [PLN/pc]
80	100	18,03
100	150	22,47
125	100	26,92
150	70	32,15
160	100	34,15
180	50	35,70
200	75	37,59
250	40	39,50

øD [mm]	Op. ¹⁾	Cena [PLN/szt.] • Price [PLN/pc]
315	30	43,61
355	32	47,73
400	30	48,72
500	25	74,97
630	34	115,69
800		190,66
1000		249,62

¹⁾ Ilość [szt./opak.] • Quantity [pcs/pack.]

Wykonanie z: blachy stalowej ocynkowanej - w klasie ocynku Z275, minimalna masa powłoki obustronnie 275 g/m², zgodnie z PN-EN 10346.

Completed out of: galvanized steel - in class Z275, min. mass of two-sided zinc coat 275 g/m² according to the PN-EN 10346.



Sztucer cylindryczny pod kątem 45° bez uszczelki

• 45° flat take-off without gasket

ILE 45



øD [mm]	Cena [PLN/szt.] • Price [PLN/pc]
80	21,24
100	22,58
125	24,81
140	25,03
150	25,03
160	28,48
180	34,38
200	38,60
224	42,71
250	55,18

øD [mm]	Cena [PLN/szt.] • Price [PLN/pc]
280	66,30
300	70,64
315	74,09
355	85,88
400	139,83
450	151,06
500	161,19
560	174,54
630	300,24

Sztucer cylindryczny pod kątem 45° z uszczelką

• 45° flat take-off with gasket

ILL 45



øD [mm]	Cena [PLN/szt.] • Price [PLN/pc]
80	34,04
100	36,04
125	39,60
140	40,05
150	40,05
160	45,72
180	54,95
200	61,62
224	68,30
250	88,21

øD [mm]	Cena [PLN/szt.] • Price [PLN/pc]
280	106,01
300	113,02
315	118,48
355	137,39
400	223,82
450	241,62
500	257,85
560	279,21
630	480,22

Wykonanie z: blachy stalowej ocynkowanej - w klasie ocynku Z275, minimalna masa powłoki obustronnie 275 g/m², zgodnie z PN-EN 10346.

Completed out of: galvanized steel - in class Z275, min. mass of two-sided zinc coat 275 g/m² according to the PN-EN 10346.



Sztucer cylindryczny prosty tłoczony SAFE bez uszczelki

• Pressed straight branching without gasket

ILR



øD [mm]	Op. ¹⁾	Cena [PLN/szt.] • Price [PLN/pc]
80	40	17,13
100	50	21,03
125	70	24,92

øD [mm]	Op. ¹⁾	Cena [PLN/szt.] • Price [PLN/pc]
150	55	29,48
160	42	32,59
200	30	39,16

øD [mm]	Op. ¹⁾	Cena [PLN/szt.] • Price [PLN/pc]
250	18	46,49
315	18	59,18

Sztucer cylindryczny prosty tłoczony z uszczelką

• Pressed straight branching with gasket

ILRL



øD [mm]	Op. ¹⁾	Cena [PLN/szt.] • Price [PLN/pc]
80	40	30,14
100	50	34,71
125	70	39,50

øD [mm]	Op. ¹⁾	Cena [PLN/szt.] • Price [PLN/pc]
150	55	45,06
160	42	51,28
200	30	56,29

øD [mm]	Op. ¹⁾	Cena [PLN/szt.] • Price [PLN/pc]
250	18	69,20
315	18	83,43

Sztucer cylindryczny prosty osiatkowany • Net straight branching

ESNE



øD [mm]	Op. ¹⁾	Cena [PLN/szt.] • Price [PLN/pc]
80	65	70,42
100	80	70,42
125	63	70,42
150	40	71,76
160	35	71,76

øD [mm]	Op. ¹⁾	Cena [PLN/szt.] • Price [PLN/pc]
180	35	72,87
200	50	82,99
250	30	98,23
315	20	111,24
355	20	121,25

øD [mm]	Op. ¹⁾	Cena [PLN/szt.] • Price [PLN/pc]
400	20	132,27
500	25	173,43
630		236,16
800		296,57

¹⁾ Ilość [szt./opak.] • Quantity [pcs/pack.]

Wykonanie z: blachy stalowej ocynkowanej - w klasie ocynku Z275, minimalna masa powłoki obustronnie 275 g/m², zgodnie z PN-EN 10346.

Completed out of: galvanized steel - in class Z275, min. mass of two-sided zinc coat 275 g/m² according to the PN-EN 10346.



Przewód półelastyczny aluminiowy • Semi-rigid aluminium duct

S-FLEX

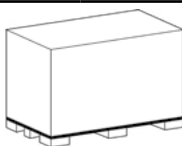

P1
L×B×H - 1200 × 800 × 800 (mm)
opak./paleta - od 1 do 3
• pack./palette - from 1 to 3

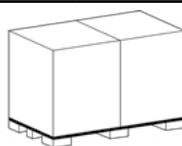

P2
L×B×H - 600 × 800 × 800 (mm)
opak./paleta - od 2 do 6
• pack./palette - from 2 to 6

øD [mm]	Na sztuki • Per piece		Opakowanie kartonowe P1 • Cardboard box P1				Opakowanie kartonowe P2 • Cardboard box P2			
	Cena • Price [PLN]		Cena • Price [PLN]		Ilość • Quantity	Cena • Price [PLN]	Cena • Price [PLN]		Ilość • Quantity	Cena • Price [PLN]
	1 m	3 m	1 m	3 m	szt./opak. • pc/pack.	opak. • pack.	1 m	3 m	szt./opak. • pc/pack.	opak. • pack.
80	16,98	50,94	15,35	46,05	125	5 756,25	15,93	47,79	54	2 580,66
100	18,13	54,39	16,52	49,56	81	4 014,36	16,98	50,94	42	2 139,48
120	21,63	64,89	19,66	58,98	53	3 125,94				
125	22,56	67,68	20,46	61,38	53	3 253,14				
130	23,03	69,09	21,04	63,12	48	3 029,76				
150	26,04	78,12	23,72	71,16	38	2 704,08				
160	28,49	85,47	25,82	77,46	32	2 478,72				
180	31,74	95,22	28,95	86,85	24	2 084,40				
200	35,11	105,33	31,97	95,91	20	1 918,20				
250	44,53	133,59	40,58	121,74	13	1 582,62				
315	59,18	177,52								

Opakowania zbiorcze - mix średnic • Mix boxes

D [mm]	Ilość [szt./opak.] • Quantity [pc/pack.]	Opakowanie kartonowe • Cardboard box	
100 - 125 - 160	32	P2	Na zamówienie • On request
100 - 125 - 160 - 200	20	P2	

Przewód aluminiowy elastyczny nieizolowany

• Non-insulated aluminium flexible duct

AF012



øD [mm]	Op. ¹⁾	Cena / opak. • Price / pack. [PLN / 10 m]
83	325	179,51
102	320	186,26
127	238	236,94
152	156	290,89
162	156	309,83
203	100	370,29
229		453,42
254	64	488,88

øD [mm]	Op. ¹⁾	Cena / opak. • Price / pack. [PLN / 10 m]
305	42	593,17
315	42	604,56
356	18	630,95
406	10	914,39
458	10	1 073,45
508		1 235,50
630		1 473,61

Przewód aluminiowy elastyczny izolowany termicznie i akustycznie

• Thermally and acoustically insulated aluminium flexible duct

AF019



øD [mm]	Op. ¹⁾	Cena / opak. • Price / pack. [PLN / 10 m]
83	112	553,40
102	84	616,07
127	60	682,56
152	50	737,80
162	50	793,14
203	36	933,35
229	21	1 084,48
254	21	1 184,24

øD [mm]	Op. ¹⁾	Cena / opak. • Price / pack. [PLN / 10 m]
305	18	1 383,51
315	18	1 457,22
356	18	1 560,47
406	10	2 090,96
458	10	2 222,69
508		2 358,71
630		3 103,49

Przewód elastyczny AF-019 z dodatkową paroszczelną folią poliesterową

• AF-019 Insulated flexible duct with additional layer of perforated polyester foil

AF013



øD [mm]	Op. ¹⁾	Cena / opak. • Price / pack. [PLN / 10 m]
83	112	585,84
102	84	652,23
127	60	722,56
152	50	781,16
162	50	839,75
203	36	988,22
229	21	1 148,31
254	21	1 253,88

øD [mm]	Op. ¹⁾	Cena / opak. • Price / pack. [PLN / 10 m]
305	18	1 464,77
315	18	1 542,90
356	18	1 652,30
406	10	2 213,96
458	10	2 353,60
508		2 497,53
630		3 286,12

¹⁾ Ilość [szt./paleta] • Quantity [pcs/palette]



Przewód aluminiowy elastyczny izolowany odporny do +140°C

• Insulated aluminium duct temperature resistant to +140°C

M0izo



øD [mm]	Opakowanie [szt.] • Package [pcs]	Cena / opak. • Price / pack. [PLN / 10 m]
83		618,39
102	52	688,61
127	48	762,68
152	30	824,65
163	30	886,49
203	24	1 043,09
229		1 212,26
254	14	1 323,51
305		1 546,16
315	12	1 628,59
356	12	1 744,04
406	10	2 486,13
458	10	2 642,73
508	8	2 804,46

Otulina 25 mm do izolacji rur, zewnętrzny zbrojony płaszcz aluminiowy

• 25 mm pipe insulation with the external reinforced aluminium coat

SLEEVE



øD [mm]	Cena / opak. • Price / pack. [PLN / 10 m]	øD [mm]	Cena / opak. • Price / pack. [PLN / 10 m]
83	Z	254	530,16
102	310,39	305	Z
127	340,35	315	653,77
152	360,03	356	Z
163	379,61	406	Z
203	436,82	458	Z
229	Z	508	Z

¹⁾ Ilość [szt./paleta] • Quantity [pcs/palette]

Z - cena na zapytanie • price on inquiry

Przewód elastyczny aluminium laminowany PVC

• PVC laminated aluminium flexible duct

COMBIFLEX



øD [mm]	Cena / opak. • Price / pack. [PLN / 10 m]
83	241,70
102	262,75
127	315,30
152	396,10
163	412,27
203	513,29
229	606,30

øD [mm]	Cena / opak. • Price / pack. [PLN / 10 m]
254	671,06
305	804,53
315	828,59
356	1 030,77
406	1 240,86
457	Z
508	Z

Przewód elastyczny z PVC o podwyższonej wytrzymałości

• Reinforced PVC flexible duct

POLYFLEX HEAVY DUTY



øD [mm]	Cena / opak. • Price / pack. [PLN / 10 m]
83	475,74
102	559,69
127	672,80
152	757,44
163	802,79
203	972,29
229	1 102,40

øD [mm]	Cena / opak. • Price / pack. [PLN / 10 m]
254	1 271,90
305	1 560,23
315	1 741,13
356	1 893,78
406	2 216,06
458	2 829,33
508	3 264,49

Z - cena na zapytanie • price on inquiry



Kanały i kształtki prostokątne typ AI • Rectangular ducts and fittings, type AI



Standard wykonania:

- kanały z blachy ocynkowanej wg Normy DIN 24190, 24191
- II klasa szczelności wg. DIN 24194
- stopień ciśnienia 1-4 wg. DIN 24190 i 24191
- obmiar DIN 18 379.

Standard manufacturing:

- galvanized steel ducts according to DIN 24190, 24191
- air tightness class II according to DIN 24194
- pressure level 1-4 according to DIN 24190 i 24191.

Wymiar boku • Dimension [mm]	Grubość blachy • Sheet thickness [mm]
	Klasa N • Class N
100 - 500	0,50
501 - 700	0,60
701 - 900	0,70
> 900	1,00

Nazwa • Name [mm]	Cena • Price [PLN/m ²]		
	Zamówienie • Order < 200 m ²	Zamówienie • Order 200 - 500 m ²	Zamówienie • Order > 500 m ²
Kanały (długość boku do 2500 mm) • Ducts (side length up to 2500 mm)	98,78	86,54	74,20
Kształtki (długość boku do 2500 mm) • Fittings (side length up to 2500 mm)	114,35	102,01	89,55

Powierzchnia przewodów wentylacyjnych

Obmiar powierzchni przewodów wentylacyjnych prostokątnych jest zgodny z normą DIN 18379.

1. Kształtka, której powierzchnia jest mniejsza niż 1,0 m², jest liczona jako kształtka o powierzchni 1,0 m².
2. Kanał, którego powierzchnia jest mniejsza niż 1,0 m², jest liczony jako kształtka o powierzchni 1,0 m².
3. Kanał prostokątny, którego długość L ≤ 900 mm jest liczony jako kształtka.
4. Standardowa długość kanałów prostokątnych L=1250 mm. W przypadku zamówień kanałów o innej długości niż standardowa, naliczana jest dodatkową opłatą w wysokości 10% ich ceny.

Ventilation ducts surface

The surface area of rectangular ventilation ducts complies with the DIN 18379 standard.

1. A fitting with a surface area of less than 1.0 m² is calculated as a fitting surface of 1.0 m².
2. A duct with a surface area of less than 1.0 m² is calculated as a fitting surface of 1.0 m².
3. A rectangular duct whose length L ≤ 900mm is calculated as a fitting.
4. The standard length of rectangular ducts is L = 1250mm. In case of orders for ducts of a different length than the standard one, there is an additional fee of 10% of their price.



Elastyczny przewód dwuwarstwowy • Double layer elastic duct

EPD



EPD



EPD-IP

Typ • Type	Średnica • Diameter [mm]	Długość • Length [mb]	Wytrzymałość na ściskanie • Compression resistance [N]	Cena [PLN/szt.] • Price [PLN/pc]
EPD×63	63	50	450	735,30
EPD×75	75	50	450	735,30
EPD×90	90	50	450	894,37

EPD-IP×75	75	50	450	612,93
------------------	----	----	-----	--------

Obejście przewodu proste

• Duct bypass

OPP



Typ • Type	Cena [PLN/szt.] • Price [PLN/pc]
OPP×63	122,36
OPP×75	122,36
OPP×90	146,84

Uszczelka do przewodu

• Duct sealing

UPE



Typ • Type	Cena [PLN/szt.] • Price [PLN/pc]
UPE×63	3,78
UPE×75	3,78
UPE×90	4,89

Łącznik do przewodu

• Duct connector

LPE-P



Typ • Type	Cena [PLN/szt.] • Price [PLN/pc]
LPE-P×63	8,67
LPE-P×75	8,67
LPE-P×90	9,78

Mocowanie przewodu

• Duct clamp

MPE



Typ • Type	Cena [PLN/szt.] • Price [PLN/pc]
MPE×63	6,23
MPE×75	6,23
MPE×90	7,34

Zaślepka do przewodu

• Fitting end cap

ZPE



Typ • Type	Cena [PLN/szt.] • Price [PLN/pc]
ZPE×63	3,78
ZPE×75	3,78
ZPE×90	4,89



Rozdzielacze przelotowe dwurzędowe • Double row through manifolds

RPD / RPDI



Typ • Type	Cena [PLN/szt.] • Price [PLN/pc]
nieizolowane	
RPD-8×63/160	306,58
RPD-8×75/160	306,58
RPD-8×90/160	362,98
izolowane	
RPDI-8×63/160	423,15
RPDI-8×75/160	423,15
RPDI-8×90/160	490,57

Typ • Type	Cena [PLN/szt.] • Price [PLN/pc]
nieizolowane	
RPD-10×63/200	355,63
RPD-10×75/200	355,63
RPD-10×90/200	404,69
izolowane	
RPDI-10×63/200	459,98
RPDI-10×75/200	459,98
RPDI-10×90/200	527,39



Typ • Type	Cena [PLN/szt.] • Price [PLN/pc]
nieizolowane	
RPD-12×63/200	380,21
RPD-12×75/200	380,21
RPD-12×90/200	441,51
izolowane	
RPDI-12×63/200	515,15
RPDI-12×75/200	515,15
RPDI-12×90/200	588,69

Typ • Type	Cena [PLN/szt.] • Price [PLN/pc]
nieizolowane	
RPD-14×63/200	429,28
RPD-14×75/200	429,28
RPD-14×90/200	478,33
izolowane	
RPDI-14×63/200	588,69
RPDI-14×75/200	588,69
RPDI-14×90/200	668,44



Typ • Type	Cena [PLN/szt.] • Price [PLN/pc]
nieizolowane	
RPD-18×63/200	521,27
RPD-18×75/200	521,27
RPD-18×90/200	594,91

Typ • Type	Cena [PLN/szt.] • Price [PLN/pc]
izolowane	
RPDI-18×63/200	711,39
RPDI-18×75/200	711,39
RPDI-18×90/200	821,73



Rozdzielacze kątowe jednorzędowe • Single row angular manifolds

RKJ / RKJI



Typ • Type	Cena [PLN/szt.] • Price [PLN/pc]
nieizolowane	
RKJ-8×63/160	220,82
RKJ-8×75/160	220,82
RKJ-8×90/160	245,29
izolowane	
RKJI-8×63/160	282,11
RKJI-8×75/160	282,11
RKJI-8×90/160	318,92

Typ • Type	Cena [PLN/szt.] • Price [PLN/pc]
nieizolowane	
RKJ-10×63/200	282,11
RKJ-10×75/200	282,11
RKJ-10×90/200	331,16
izolowane	
RKJI-10×63/200	367,98
RKJI-10×75/200	367,98
RKJI-10×90/200	429,28



Typ • Type	Cena [PLN/szt.] • Price [PLN/pc]
nieizolowane	
RKJ-12×63/200	331,16
RKJ-12×75/200	331,16
RKJ-12×90/200	367,98
izolowane	
RKJI-12×63/200	417,04
RKJI-12×75/200	417,04
RKJI-12×90/200	478,33

Typ • Type	Cena [PLN/szt.] • Price [PLN/pc]
nieizolowane	
RKJ-14×63/200	355,63
RKJ-14×75/200	355,63
RKJ-14×90/200	404,69
izolowane	
RKJI-14×63/200	417,04
RKJI-14×75/200	417,04
RKJI-14×90/200	478,33



Typ • Type	Cena [PLN/szt.] • Price [PLN/pc]
nieizolowane	
RKJ-16×63/200	380,21
RKJ-16×75/200	380,21
RKJ-16×90/200	429,28

Typ • Type	Cena [PLN/szt.] • Price [PLN/pc]
izolowane	
RKJI-16×63/200	429,28
RKJI-16×75/200	429,28
RKJI-16×90/200	490,57

SYSTEM WENTYLACJI ROZDZIELACZOWEJ

Rozdzielacze kątowe niesymetryczne, skrzynki rozprężne

• Asymmetric angular manifolds, plenum boxes



Rozdzielacze kątowe niesymetryczne • Asymmetric angular manifolds

RK / RKI



Typ • Type	Cena [PLN/szt.] • Price [PLN/pc]
nieizolowane	
RK-LR-10×63/160	306,58
RK-LR-10×75/160	306,58
RK-LR-10×90/160	355,63

Typ • Type	Cena [PLN/szt.] • Price [PLN/pc]
izolowane	
RKI-LR-10×63/160	398,68
RKI-LR-10×75/160	398,68
RKI-LR-10×90/160	459,98

Skrzynki rozprężne • Plenum boxes

SR-T



Typ • Type	Cena [PLN/szt.] • Price [PLN/pc]
SR-T1×63/100	85,88
SR-T1×75/100	85,88
SR-T1×90/100	110,35

Typ • Type	Cena [PLN/szt.] • Price [PLN/pc]
SR-T2×63/125	98,12
SR-T2×75/125	98,12
SR-T2×90/125	122,70



Typ • Type	Cena [PLN/szt.] • Price [PLN/pc]
SR-T3×63/125	128,81
SR-T3×75/125	128,81
SR-T3×90/125	153,40

Typ • Type	Cena [PLN/szt.] • Price [PLN/pc]
SR-T4×63/160	159,41
SR-T4×75/160	159,41
SR-T4×90/160	196,23



Przepustnica jednopłaszczyznowa okrągła bez uszczelki

• Circular duct damper without gasket

DS(E)



øD [mm]	Opakowanie [szt.] • Package [pcs]	Cena [PLN/szt.] • Price [PLN/pc]
80	60	77,32
100*	40	77,32
125*	27	77,32
150*	30	80,65
160*	24	84,77
200*	36	88,55
250*	36	97,22
315*	25	111,01
355	30	144,95
400	15	152,51
500		192,00
630		229,05
800		337,39

Przepustnica jednopłaszczyznowa okrągła z uszczelką

• Circular duct damper with gasket

DSL



øD [mm]	Opakowanie [szt.] • Package [pcs]	Cena [PLN/szt.] • Price [PLN/pc]
80	60	100,45
100	40	100,45
125	27	100,45
150	30	104,79
160	24	110,24
200	36	115,14
250	36	126,37
315	25	144,28
355	30	188,44
400	15	198,34
500		226,93
630		270,76
800		398,80

* Tylko w wersji DS - Only DS version



Przepustnica jednopłaszczyznowa okrągła z uszczelką, szczelna odcinająca

• Circular duct damper with gasket, airtight

DTL / DTBL

DTL



DTBL



DTL	
øD [mm]	Cena [PLN/szt.] • Price [PLN/pc]
80	156,74
100	156,74
125	156,74
150	162,52
160	171,98
200	179,54
250	205,79
315	235,16
355	240,61
400	280,99
500	321,71
630	383,55
800	565,10

DTBL POD SIŁOWNIK • FOR ACTUATORS	
øD [mm]	Cena [PLN/szt.] • Price [PLN/pc]
80	188,10
100	188,10
125	188,10
150	194,90
160	206,36
200	215,36
250	247,06
315	282,11
355	288,78
400	337,17
500	385,89
630	460,31
800	678,12

Przepustnica jednopłaszczyznowa okrągła (stal kwasoodporna)

• Circular duct damper (stainless steel)

DSE-S

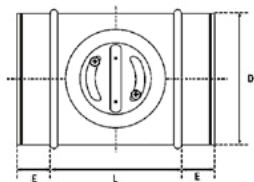

øD [mm]	Cena [PLN/szt.] • Price [PLN/pc]
100	357,19
125	357,19
160	391,79
200	409,14
250	448,86
315	512,59
400	704,82
500	887,14
630	1 058,23

Przepustnica typu IRIS • IRIS damper

IRIS



øD [mm]	Cena [PLN/szt.] • Price [PLN/pc]
100	328,94
125	387,34
150	441,51
160	441,51
200	473,99
250	779,12

øD [mm]	Cena [PLN/szt.] • Price [PLN/pc]
300	891,59
315	891,59
400	1 092,27
500	1 739,69
630	2 629,71
800	5 305,14

Przepustnica zwrotna z uszczelką • Back draft damper with gasket

RSK





øD [mm]	Cena [PLN/szt.] • Price [PLN/pc]
100	79,54
125	85,76
150	100,56
160	105,01
200	133,49

øD [mm]	Cena [PLN/szt.] • Price [PLN/pc]
250	217,92
315	272,31
355	352,30
400	470,77



Formowalna przepustnica do kanałów okrągłych		INNOV
	øD [mm]	Cena [EUR/szt.] • Price [EUR/pc]
	80	3,90
	100	4,50
	125	5,40
	160	7,40
	200	12,40
	250	26,60
	315	38,40

Przepustnica zwrotna z uszczelką • Back draft damper with gasket		RSK-P	
	øD [mm]	Opakowanie [szt.] • Package [pcs]	Cena [PLN/szt.] • Price [PLN/pc]
	100		50,40
	125	140	53,20
	160	70	81,20

Przepustnica zwrotna z uszczelką i magnetycznym domknięciem • Back draft damper with gasket and magnetic closure		RSK-PM	
	øD [mm]	Opakowanie [szt.] • Package [pcs]	Cena [PLN/szt.] • Price [PLN/pc]
	100		86,80
	125	140	89,60
	160	70	112,00



Nastawne regulatory stałego przepływu • Flow regulators

RDR / RDR HP



Łatwa regulacja żądanej nastawy przepływu.

Trwale ustalenie wartości przepływu powietrza ustalane za pomocą śrubokrętu „TORX 10”.

Konstrukcja z tworzywa sztucznego (M1) oraz ze stali ocynkowanej (na tulejach o średnicach od $\varnothing 150$ do $\varnothing 250$ mm). Maksymalna temperatura pracy wynosi 60°C .

Easy adjustment.

The requested air flow is fixed by a screwdriver «torx n°10».

Made in plastic material (classified M1) and in galvanized steel for sleeves in $\varnothing 150$ to $\varnothing 250$ mm.

Use with a maximum temperature of 60°C .

Typ • Type	Średnica • Diameter [mm]	Przepływ • Flow [m^3/h]	Zakres ciśnień • Pressure range [Pa]	Cena [EUR/szt.] • Price [EUR/pc]
RDR 80	80	15 - 50	50 - 250	13,25
RDR 100*	100	50 - 100		16,04
RDR 125*	125	100 - 180		18,25
RDR 160*	160	180 - 300		27,08
RDR 200*	200	300 - 500		40,92
RDR 250*	250	300 - 500 M3		52,70
		450 - 800 M3		60,35
RDR HP 80	80	25 - 90	150 - 600	14,72
RDR HP 100	100	90 - 170		17,81
RDR HP 125	125	180 - 300		20,02
RDR HP 160	160	300 - 500		29,73
RDR HP 200	200	500 - 850		45,34
RDR HP 250	250	500 - 850 M3		58,59
		850 - 1300 M3		67,71

* - dostępność z magazynu



Przepustnica wielopłaszczyznowa aluminiowa

• Multi-leaf aluminium dampers

PW

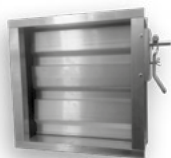

Wykonanie: • Material:

- aluminium (obudowa + żaluzja) • aluminium cover
- tworzywo PA (kółka napędowe) • aluminium louver slats
- guma (uszczelki, żaluzja) • driving cogs made of PA material

Z uwagi na ograniczenia transportowe, jeden z wymiarów (B lub H) nie może być większy niż 2000 mm.

• Because of transport limitations one of the dimensions (B or H) cannot surpass 2000 mm.

H [mm]	Cena [PLN/szt.] • Price [PLN/pc]									
	B [mm]									
	300	400	600	800	1000	1200	1400	1600	1800	2000
200	309,00	342,00	386,00	431,00	474,00	741,00	884,00	1 067,00	1 133,00	1 256,00
300	389,00	415,00	468,00	523,00	576,00	900,00	1 034,00	1 247,00	1 323,00	1 400,00
400	442,00	475,00	540,00	605,00	668,00	1 048,00	1 197,00	1 469,00	1 561,00	1 655,00
600	551,00	595,00	681,00	767,00	854,00	1 343,00	1 524,00	1 915,00	2 038,00	2 161,00
800	701,00	757,00	863,00	970,00	1 078,00	1 695,00	1 964,00	2 418,00	2 574,00	2 727,00
1000	810,00	875,00	1 005,00	1 134,00	1 304,00	1 989,00	2 289,00	2 921,00	3 107,00	3 294,00
1200	1 313,00	1 422,00	1 638,00	1 851,00	2 126,00	2 284,00	2 616,00	3 371,00	3 584,00	3 800,00
1400	1 472,00	1 595,00	1 898,00	2 145,00	2 391,00	2 636,00	2 998,00	3 874,00	4 120,00	4 367,00
1600	1 685,00	1 821,00	2 101,00	2 378,00	2 711,00	2 987,00	3 324,00	4 190,00	4 596,00	4 930,00
1800	1 841,00	1 994,00	2 301,00	2 668,00	2 973,00	3 340,00	3 649,00	4 823,00	5 073,00	5 439,00
2000	1 997,00	2 166,00	2 560,00	2 899,00	3 297,00	3 636,00	3 975,00	5 269,00	5 606,00	5 945,00

Możliwość wykonania przepustnicy o indywidualnych wymiarach w zakresie

H=200÷2000 mm oraz B=200÷2000 mm - cena na zapytanie ofertowe

• Possible manufacturing within range H =200-2000 and B=200-2000 - price on inquiry.



Przepustnica samoczynna kanałowa • Automatic duct damper

PSK



Materiał • Material:

- profil, żaluzja - aluminium • shape, louver - aluminium
- prowadnice żaluzji - tworzywo sztuczne • louver drives - plastic

Wykonanie z aluminium zapobiega powstawaniu korozji.

• Aluminium prevents the occurrence of corrosion.

H [mm]	Cena [PLN/szt.] • Price [PLN/pc]						
	B [mm]						
	300	400	600	800	1000	1200	1400
300	467,00	516,00	611,00	706,00	801,00	896,00	1 037,00
400	551,00	605,00	717,00	828,00	939,00	1 048,00	1 205,00
600	717,00	787,00	928,00	1 070,00	1 214,00	1 355,00	1 542,00
800	926,00	1 013,00	1 186,00	1 357,00	1 531,00	1 705,00	1 968,00
1000	1 091,00	1 195,00	1 398,00	1 602,00	1 852,00	2 009,00	2 302,00
1200	1 257,00	1 374,00	1 610,00	1 843,00	2 123,00	2 313,00	2 639,00
1400	1 423,00	1 556,00	1 865,00	2 131,00	2 397,00	2 663,00	3 022,00
1600	1 632,00	1 781,00	2 077,00	2 376,00	2 718,00	3 013,00	3 356,00
1800	1 797,00	1 963,00	2 289,00	2 663,00	2 992,00	3 364,00	3 692,00
2000	1 963,00	2 142,00	2 547,00	2 905,00	3 309,00	3 671,00	4 029,00

Przepustnica samoczynna ścienna • Automatic wall damper

PSS



Materiał • Material:

- profil, żaluzja - aluminium • shape, louver - aluminium
- prowadnice żaluzji - tworzywo sztuczne • louver drives - plastic

Wykonanie z aluminium zapobiega powstawaniu korozji.

• Aluminium prevents the occurrence of corrosion

H [mm]	Cena [PLN/szt.] • Price [PLN/pc]						
	B [mm]						
	300	400	600	800	1000	1200	1400
300	481,00	531,00	629,00	727,00	825,00	923,00	1 068,00
400	568,00	624,00	738,00	853,00	967,00	1 079,00	1 242,00
600	738,00	811,00	956,00	1 102,00	1 250,00	1 395,00	1 588,00
800	954,00	1 043,00	1 222,00	1 398,00	1 577,00	1 756,00	2 027,00
1000	1 124,00	1 230,00	1 440,00	1 650,00	1 907,00	2 069,00	2 371,00
1200	1 295,00	1 415,00	1 658,00	1 899,00	2 187,00	2 383,00	2 718,00
1400	1 465,00	1 602,00	1 921,00	2 195,00	2 469,00	2 743,00	3 112,00
1600	1 681,00	1 834,00	2 139,00	2 447,00	2 799,00	3 104,00	3 456,00
1800	1 851,00	2 022,00	2 357,00	2 743,00	3 082,00	3 465,00	3 803,00
2000	2 022,00	2 206,00	2 623,00	2 992,00	3 409,00	3 781,00	4 150,00

Możliwość wykonania przepustnicy o wymiarach w zakresie H=200÷2000 mm oraz B=200÷1400 mm - cena na zapytanie.

• Possible manufacturing within range H=200÷2000 mm and B=200÷1400 mm - price on inquiry.



Czerpnia/wyrzutnia prostokątna stalowa ocynkowana

• Galvanized steel rectangular air intake/exhauster

CW



Stal ocynkowana, system profili stalowych • galvanized steel, steel shapes system.

Minimalna wysokość czerpni • min. height of the air intake: H = 200 mm.

Maks. wielkość czerpni • max. size of the air intake: B × H = 3000 mm × 2000 mm.

H [mm]	Cena [PLN/szt.] • Price [PLN/pc]									
	B [mm]									
	300	400	600	800	1000	1200	1400	1600	1800	2000
300	309,00	345,00	383,00	441,00	519,00	638,00	869,00	975,00	1 058,00	1 134,00
400	354,00	404,00	429,00	490,00	575,00	692,00	948,00	1 030,00	1 101,00	1 188,00
600	400,00	462,00	523,00	577,00	677,00	811,00	1 101,00	1 204,00	1 296,00	1 378,00
800	494,00	559,00	628,00	711,00	813,00	975,00	1 326,00	1 444,00	1 552,00	1 660,00
1000	628,00	707,00	787,00	892,00	965,00	1 160,00	1 563,00	1 685,00	1 793,00	1 927,00
1200	737,00	813,00	904,00	1 024,00	1 123,00	1 327,00	1 793,00	1 927,00	2 054,00	2 188,00
1400	1 157,00	1 275,00	1 418,00	1 587,00	1 742,00	1 895,00	2 044,00	2 193,00	2 341,00	2 490,00
1600	1 321,00	1 455,00	1 598,00	1 793,00	1 951,00	2 115,00	2 223,00	2 449,00	2 618,00	2 777,00
1800	1 500,00	1 650,00	1 803,00	2 070,00	2 193,00	2 373,00	2 561,00	2 730,00	2 920,00	3 110,00
2000	1 695,00	1 843,00	2 038,00	2 233,00	2 305,00	2 618,00	2 822,00	3 007,00	3 212,00	3 413,00

Czerpnia/wyrzutnia prostokątna aluminiowa

• Aluminium rectangular air intake/exhauster

CWA

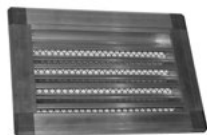

Aluminium, system profili aluminiowych • aluminium, aluminium shapes system.

Minimalna wysokość czerpni • min. height of the air intake: H = 200 mm.

Maks. wielkość czerpni • max. size of the air intake: B × H = 3000 mm × 2000 mm.

H [mm]	Cena [PLN/szt.] • Price [PLN/pc]									
	B [mm]									
	300	400	600	800	1000	1200	1400	1600	1800	2000
300	418,00	450,00	580,00	712,00	800,00	907,00	1 026,00	1 194,00	1 343,00	1 490,00
400	531,00	608,00	750,00	914,00	1 022,00	1 136,00	1 292,00	1 455,00	1 612,00	1 800,00
600	603,00	695,00	915,00	1 075,00	1 204,00	1 331,00	1 501,00	1 701,00	1 897,00	2 087,00
800	743,00	841,00	1 098,00	1 325,00	1 446,00	1 600,00	1 808,00	2 041,00	2 272,00	2 514,00
1000	896,00	1 015,00	1 312,00	1 586,00	1 715,00	1 902,00	2 129,00	2 381,00	2 625,00	2 918,00
1200	1 058,00	1 223,00	1 508,00	1 821,00	1 997,00	2 179,00	2 444,00	2 723,00	3 007,00	3 312,00
1400	1 227,00	1 417,00	1 747,00	2 084,00	2 285,00	2 488,00	2 786,00	3 100,00	3 428,00	3 771,00
1600	1 401,00	1 616,00	1 968,00	2 353,00	2 561,00	2 777,00	3 031,00	3 461,00	3 832,00	4 205,00
1800	1 591,00	1 832,00	2 220,00	2 716,00	2 878,00	3 114,00	3 491,00	3 860,00	4 275,00	4 710,00
2000	1 798,00	2 048,00	2 511,00	2 932,00	3 025,00	3 436,00	3 848,00	4 250,00	4 702,00	5 168,00

Możliwość wykonania czerpni o wymiarach w zakresie H=200+2000 mm oraz B=200+3000 mm - cena na zapytanie.

• Possible manufacturing within range H=200+2000 mm and B=200+3000 mm - price on inquiry.



Czerpnia dachowa okrągła • Round air intake

CDO



øD [mm]	Cena [PLN/szt.] • Price [PLN/pc]
100	206,00
125	206,00
160	250,00
200	284,00
250	356,00

øD [mm]	Cena [PLN/szt.] • Price [PLN/pc]
315	467,00
400	734,00
500	946,00
630	1 357,00

Wyrzutnia dachowa okrągła • Round air exhauster

WDO-C



øD [mm]	Cena [PLN/szt.] • Price [PLN/pc]
100	156,00
125	156,00
160	200,00
200	200,00
250	256,00

øD [mm]	Cena [PLN/szt.] • Price [PLN/pc]
315	367,00
400	556,00
500	756,00
630	1 213,00

Wyrzutnia z kołnierzem VKPK • Air exhauster with VKPK flange

HF



øD [mm]	Cena [PLN/szt.] • Price [PLN/pc]
100	280,00
125	290,00
160	343,00
200	418,75
250	500,00

øD [mm]	Cena [PLN/szt.] • Price [PLN/pc]
315	700,00
400	1 230,00
500	1 765,00
630	2 730,00
800	3 890,00

OSPRZĘT WENTYLACYJNY

Czerpnie/wyrzutnie, wywietrzaki cylindryczne

• Air intakes/exhausters, round gravity ventilators



Wyrzutnia z odejściem na rurę • Air exhauster to fit round duct

HN



øD [mm]	Cena [PLN/szt.] • Price [PLN/pc]
100	280,00
125	290,00
160	343,00
200	418,75
250	500,00

øD [mm]	Cena [PLN/szt.] • Price [PLN/pc]
315	700,00
400	1 230,00
500	1 765,00
630	2 730,00
800	3 890,00

Czerpnia dachowa • Roof air intake

K



ød [mm]	øD [mm]	Cena [PLN/szt.] • Price [PLN/pc]
100	200	160,00
125	225	160,00
150	250	186,00
160	260	186,00
180	285	195,00
200	315	195,00

ød [mm]	øD [mm]	Cena [PLN/szt.] • Price [PLN/pc]
250	400	266,00
315	500	320,00
355	550	391,00
400	600	426,00
450	650	498,00
500	700	569,00

Ośłona dachowa • Ventilation cap

KV



≤ ø200



> ø200

ød [mm]	Cena [PLN/szt.] • Price [PLN/pc]
100	114,00
125	121,00
150	121,00
160	121,00
180	141,00
200	147,00
250	143,00

ød [mm]	Cena [PLN/szt.] • Price [PLN/pc]
300	155,00
315	173,00
355	204,00
400	242,00
450	246,00
500	293,00
630	405,00

Wywietrzak cylindryczny • Round gravity ventilator

WDC



øD [mm]	Cena [PLN/szt.] • Price [PLN/pc]
100	302,00
125	334,00
160	391,00
200	522,00
250	650,00

øD [mm]	Cena [PLN/szt.] • Price [PLN/pc]
315	845,00
400	1 079,00
500	1 848,00
630	2 455,00

Czerpnia/wyrzutnia okrągła, stal chromo-niklowa

• Round air intakes/exhausters, chrome-nickel plated

VLA



Typ - Type	øA [mm]	øB [mm]	C [mm]	Cena [PLN/szt.] • Price [PLN/pc]
VLA-100	97	133	52	137,71
VLA-125	120	165	52	183,10
VLA-150	145	192	62	219,37
VLA-160	155	192	62	227,26
VLA-200	195	253	62	418,37

Czerpnia/wyrzutnia okrągła, aluminium

• Round air intakes/exhausters, aluminium

KWO-AL



Typ - Type	ød [mm]	øD [mm]	H [mm]	Cena [PLN/szt.] • Price [PLN/pc]
KWO-AL 100	100	125	20	50,84
KWO-AL 125	125	150	20	57,84
KWO-AL 160	160	185	20	69,41
KWO-AL 200	200	225	20	76,31
KWO-AL 250	250	275	20	184,89
KWO-AL 315	315	350	20	242,73
KWO-AL 400	400	435	35	459,86

Czerpnia/wyrzutnia ścienna aluminiowa

• Round air intakes/exhausters, aluminium

ELB



øD [mm]	Cena [PLN/szt.] • Price [PLN/pc]
100	71,64
125	80,20
150	97,66
160	104,57
200	162,41
250	247,62
315	344,29



Drzwi rewizyjne - Access doors

RD

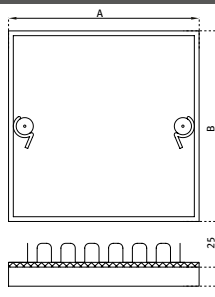

Drzwi rewizyjne na kanał prostokątny, wykonane z blachy stalowej ocynkowanej. W skład zestawu wchodzi izolowane drzwi o grubości 25 mm wraz z zamkami i ramka przystosowana do montażu na kanale. Ramka dostarczana jest z uszczelkami.

Access door for a rectangular duct. Made of galvanized steel. The set includes insulated doors with a thickness of 25 mm with locks and frame suitable for mounting in the duct. The frame is insulated with gasket.

Typ · Type	Wymiar A × B · Nominal size [mm]	Wymiar otworu montażowego · Duct opening size [mm]	Cena [PLN/szt.] · Price [PLN/pc]
RD 15	150 × 150	120 × 120	64,79
RD 20	200 × 200	170 × 170	73,44
RD 21	200 × 125	170 × 95	73,95
RD 25	250 × 250	220 × 220	92,80
RD 30	300 × 300	270 × 270	109,70
RD 31	300 × 150	270 × 120	83,12
RD 32	300 × 200	270 × 170	92,08
RD 35	350 × 350	320 × 320	133,18
RD 40	400 × 400	370 × 370	153,47
RD 42	400 × 200	370 × 170	117,01
RD 425	400 × 250	370 × 220	121,85
RD 43	450 × 300	420 × 270	145,64
RD 44	400 × 300	370 × 270	136,78
RD 45	450 × 450	420 × 420	202,50
RD 50	500 × 500	470 × 470	232,88
RD 63	600 × 300	570 × 270	193,95
RD 64	600 × 400	570 × 370	229,18
RD 65	600 × 450	570 × 420	248,75
RD 66	600 × 600	570 × 570	298,80

Klapa rewizyjna na kanał okrągły • Curved access door for round duct

KR



A × B [mm]	Średnica rury • Pipe diameter [mm]	Cena [PLN/szt.] • Price [PLN/pc]
180 × 80	Ø100 ÷ Ø125	54,06
250 × 150	Ø160 ÷ Ø400	89,22
400 × 300	Ø400 ÷ Ø800	180,77

Klapa rewizyjna na kanał prostokątny • Flat access door for rectangular duct

FAD



A × B [mm]	Cena [PLN/szt.] • Price [PLN/pc]
180 × 180	31,71
200 × 100	47,39
250 × 150	67,96
300 × 200	142,50
400 × 300	253,29
500 × 400	453,97
600 × 450	545,75

Nasada kominowa (nierdzewna) • Chimney root (stainless steel)

ROTOFLEX



øD [mm]	nyplowa dzielona • split with coupling		z kołnierzem • with flange		z podstawą • with base	
	„pletwa”	„kogut”	„pletwa”	„kogut”	„pletwa”	„kogut”
	Cena [PLN/szt.] • Price [PLN/pc]					
130	396,47	396,47	396,47	396,47	396,47	396,47
150	425,41	425,41	425,41	425,41	425,41	425,41
180	460,51	460,51	460,51	460,51	460,51	460,51
200	484,38	484,38	484,38	484,38	484,38	484,38
250	520,13	520,13	520,13	520,13	520,13	520,13
300	599,51	599,51	599,51	599,51	599,51	599,51
350	757,40	757,40	757,40	757,40	757,40	757,40



Nasada kominowa • Chimney root

CENTROWENT



øD [mm]	nyplowa • coupling		nyplowa dzielona • split with coupling		z kołnierzem • with flange		z podstawą • with base	
	CA ¹⁾	CN ¹⁾	CA ¹⁾	CN ¹⁾	CA ¹⁾	CN ¹⁾	CA ¹⁾	CN ¹⁾
	Cena [PLN/szt.] • Price [PLN/pc]							
130	249,91	348,95	306,72	379,30	340,74	414,72	339,55	442,26
150	258,44	367,20	316,98	398,95	356,40	446,90	348,30	466,34
160	260,39	392,58	347,33	436,21	365,58	458,35	352,19	474,12
200	301,21	470,12	383,62	481,25	386,86	526,07	373,79	559,98
250	417,53	634,50	521,42	601,13	490,75	707,51	477,25	708,48
300	571,43	669,49	597,24	763,34	587,09	810,11	517,86	860,54
315	466,24	726,41	625,10	×	605,45	×	569,81	×
400	779,22	×	841,64	×	824,26	×	800,17	×
450	866,16	×	941,65	×	917,46	×	886,46	×
500	909,58	×	982,48	×	1 038,96	×	1 000,40	×

¹⁾ CA - Aluminium

CN - Stal nierdzewna • Stainless steel

Kominek • Ventilation caps

VH



ød [mm]	Cena [PLN/szt.] • Price [PLN/pc]
100	79,00
125	85,00
140	87,00
150	87,00
160	98,00
180	110,00
200	115,00
224	129,00
250	147,00

ød [mm]	Cena [PLN/szt.] • Price [PLN/pc]
300	200,00
315	200,00
355	262,00
400	311,00
450	389,00
500	556,00
630	1 101,00
710	1 390,00
800	1 890,00



Kominek - Ventilation caps

VH-S



øD [mm]	Ilość [szt./opak.] • Quantity [pcs/pack.]	Cena [PLN/szt.] • Price [PLN/pc]
100	20	61,00
125	20	64,00
150		73,00
160	24	75,00
200	24	95,00
250	16	104,00
315	6	156,00

Podstawa dachowa - Roof base

PD-B

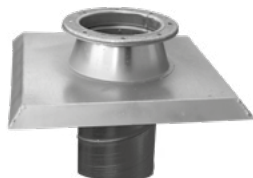

øD [mm]	Cena [PLN/szt.] • Price [PLN/pc]		
	B I	B II	B III
100	177,00	211,00	333,00
125	177,00	211,00	333,00
160	211,00	250,00	378,00
200	222,00	300,00	444,00
250	248,00	339,00	522,00
315	318,00	361,00	667,00
400	422,00	511,00	878,00
500	544,00	778,00	1 168,00
630	742,00	1 023,00	1 546,00

Podstawa dachowa prostokątna - Rectangular roof base

PD-P



Wymiar - Size A x B [mm]	Cena [PLN/szt.] • Price [PLN/pc]
250 × 250	485,00
250 × 400	560,00
250 × 630	672,00
400 × 400	847,00
400 × 630	983,00
630 × 630	1 221,00
630 × 1000	1 620,00
630 × 1600	2 130,00
1000 × 1000	2 267,00



Podstawa dachowa prostokątna • Rectangular roof base

PD-S

Produkt przystosowany do montażu następujących typów wentylatorów:

Systemair: DVS, DHS, DVSI, DVN, DVNI, DVC;

Rosenberg: DV, DH, DVS, DVWN, DVWNS, DV-G.

Wykonanie z blachy ocynkowanej zapewnia odporność na korozję.

The bases are adapted to assembly of the following ventilators:

Systemair: DVS, DHS, DVSI, DVN, DVNI, DVC;

Rosenberg: DV, DH, DVS, DVWN, DVWNS, DV-G.

It is made of the zinc coated sheet that makes anticorrosive protection.



Typ • Type	Cena [PLN/szt.] • Price [PLN/pc]
PD-S 190/225	623,00
PD-S 310/311	701,00
PD-S 355/400	834,00
PD-S 450/499/500	890,00
PD-S 560/630	1 246,00
PD-S 710	1 524,00
PD-S 800/900	1 869,00

Podstawa dachowa prostokątna tłumiąca • Rectangular muffle roof base

PD-ST

Do zastosowań o podwyższonych wymaganiach odnośnie parametrów akustycznych.

Tłumienie dźwięku przy 250Hz wynosi średnio 8 dB.

Materiał pochłaniający dźwięk jest odporny na ścieranie do prędkości 20 m/s.

Przystosowany do montażu następujących typów wentylatorów:

Systemair: DVS, DHS, DVSI, DVN, DVNI, DVC;

Rosenberg: DV, DH, DVS, DVWN, DVWNS, DV-G.

Attenuating roof base for roof ventilators is to be used in case of higher acoustic requirements.

Sound attenuation with frequency of 250 Hz is 8 dB on the average.

The sound attenuating material is resistant to wear up to 20 m/sec.

The bases are adapted to operate with the following ventilators:

Systemair: DVS, DHS, DVSI, DVN, DVNI, DVC;

Rosenberg: DV, DH, DVS, DVWN, DVWNS, DV-G



Typ • Type	Cena [PLN/szt.] • Price [PLN/pc]
PD-ST 190/225	1 300,00
PD-ST 310/311	1 665,00
PD-ST 355/400	2 120,00
PD-ST 450/499/500	2 259,00
PD-ST 560/630	3 815,00
PD-ST 710	4 748,00
PD-ST 800/900	5 994,00



Filtr kanałowy okrągły - Round duct filter

OFK



øD [mm]	Cena [PLN/szt.] - Price [PLN/pc]
100	267,00
125	267,00
160	356,00
200	378,00
250	400,00
315	434,00
355	478,00
400	545,00

Filtr kanałowy okrągły - Round duct filter

FKO

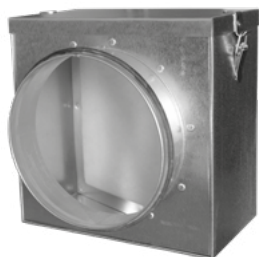

øD [mm]	A [mm]	B [mm]	Cena [PLN/szt.] - Price [PLN/pc]
100	180	180	267,00
125	180	180	267,00
160	210	180	356,00
200	250	180	378,00
250	300	180	400,00
315	370	180	434,00
355	400	180	478,00
400	450	180	545,00

Filtr kanałowy szufladowy - Cassette duct filter

FS



B [mm]	200	400	600	800	1000	1250
H [mm]	Cena [PLN/szt.] - Price [PLN/pc]					
200	538,00	538,00	666,00	746,00	800,00	880,00
400	538,00	538,00	666,00	800,00	853,00	1 119,00
600	666,00	666,00	714,00	959,00	1 147,00	1 492,00
800	746,00	800,00	933,00	1 226,00	1 599,00	1 867,00
1000	800,00	853,00	1 093,00	1 573,00	1 626,00	2 266,00
1250	880,00	1 119,00	1 413,00	1 814,00	2 266,00	2 773,00

Możliwość wykonania filtrów kanałowych o indywidualnych wymiarach w zakresie H = 200 + 1250 mm oraz B = 200 + 1250 mm - cena na zapytanie ofertowe. • Possible manufacturing within range H = 200 + 1250 mm and B = 200 + 1250 mm - price on inquiry.



Kratka typ AI z siatki stalowej ocynkowanej z ramką płaską

• Grille made of galvanized steel mesh with the flat frame

KSS



Siatka stalowa ocynkowana, wielkość oczek 12 x 12 mm.
Cena obejmuje wyłącznie kratkę bez kanału przyłączeniowego.

Pulled steel wire mesh, openings 12 x 12 mm.

Price comprises the grille only, without connecting duct.

H [mm]	Cena [PLN/szt.] • Price [PLN/pc]									
	B [mm]									
	300	400	600	800	1000	1200	1400	1600	1800	2000
300	146,00	152,00	163,00	209,00	219,00	239,00	284,00	303,00	361,00	390,00
400	155,00	160,00	202,00	216,00	223,00	250,00	299,00	310,00	374,00	399,00
600	163,00	202,00	216,00	223,00	230,00	260,00	314,00	338,00	395,00	449,00
800	209,00	216,00	223,00	230,00	246,00	274,00	360,00	410,00	494,00	561,00
1000	219,00	223,00	230,00	246,00	267,00	334,00	429,00	499,00	632,00	681,00
1200	230,00	240,00	250,00	263,00	324,00	404,00	529,00	602,00	731,00	818,00
1400	272,00	283,00	302,00	346,00	412,00	533,00	610,00	706,00	856,00	955,00
1600	317,00	325,00	353,00	429,00	521,00	625,00	738,00	818,00	1 008,00	1 125,00
1800	378,00	395,00	417,00	517,00	651,00	764,00	895,00	1 003,00	1 125,00	1 255,00
2000	408,00	417,00	469,00	591,00	717,00	856,00	999,00	1 125,00	1 255,00	1 385,00

Możliwość wykonania o indywidualnych wymiarach w zakresie H=300+1500 mm oraz B=300+1500 mm - cena na zapytanie.

• Possible manufacturing within range H=300+1500 mm oraz B=300+1500 mm - price on inquiry.



Króciec elastyczny okrągły bez kołnierzy

• Circular flexible connector pipe without flange

KEO



øD [mm]	Cena [PLN/szt.] • Price [PLN/pc]
80	26,00
100	27,00
125	31,00
160	33,00
200	36,00
250	40,00

øD [mm]	Cena [PLN/szt.] • Price [PLN/pc]
315	44,00
400	51,00
500	68,00
630	87,00
800	103,00
1000	115,00

Króciec elastyczny okrągły z kołnierzami

• Circular flexible connector pipe with flange

KEO-K

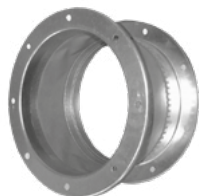

øD [mm]	Cena [PLN/szt.] • Price [PLN/pc]
80	76,00
100	83,00
125	88,00
160	107,00
200	112,00
250	133,00

øD [mm]	Cena [PLN/szt.] • Price [PLN/pc]
315	160,00
400	218,00
500	271,00
630	422,00
1000	670,00

Króciec elastyczny prostokątny • Rectangular flexible duct connector

KEP



B [mm]	200	400	600	800	1000	1250
A [mm]	Cena [PLN/szt.] • Price [PLN/pc]					
200	111,00	151,00	190,00	235,00	281,00	344,00
400	151,00	199,00	235,00	281,00	323,00	394,00
600	199,00	247,00	281,00	323,00	369,00	443,00
800	235,00	281,00	323,00	383,00	429,00	488,00
1000	281,00	323,00	369,00	429,00	478,00	548,00
1250	344,00	379,00	443,00	488,00	548,00	615,00



Tłumik akustyczny okrągły prosty • Circular silencer

SLL



W styczniu 2010 jakość tłumików okrągłych SLL potwierdziliśmy badaniami zgodnie z ISO 7235 testującego właściwości tłumiące oraz poziom strat ciśnienia w niemieckich laboratoriach firmy Muller-BBM GmbH, których wyniki okazały się ponadprzeciętnie dobre. Wszystkie szczegółowe informacje dotyczące cechy testu oraz parametrów technicznych znajdują się na naszej stronie www.centrumklima.pl.

In January 2010 we've tested whole range of round silencers SLL in accordance with ISO 7235 standard for attenuation and pressure loss in German laboratories of Muller-BBM GmbH, which proved to be more than satisfactory. All details can be found on our webpage: www.centrumklima.pl.

Izolacja 50 mm • Insulation 50 mm

∅D ₁ [mm]	100	125	160	200	250	315	355	400	450	500	560	630
L [mm]	Cena [PLN/szt.] • Price [PLN/pc]											
300	199,90	214,80	247,06	288,55	374,33	387,22	457,97	672,12	739,20	887,47	1 029,64	1 193,94
600	240,84	267,31	313,36	368,43	482,23	516,82	602,25	873,90	947,54	1 114,85	1 281,82	1 474,37
900	294,45	333,28	395,13	466,54	613,60	670,78	850,88	1 043,32	1 201,73	1 397,74	1 598,18	1 829,23
1000	312,25	355,30	422,38	499,13	657,43	722,06	914,17	1 119,07	1 286,60	1 492,06	1 703,53	1 947,59
1200	347,18	397,69	475,10	562,54	742,20	820,17	1 036,31	1 261,80	1 444,56	1 666,60	1 896,53	2 165,62

Izolacja 100 mm • Insulation 100 mm

∅D ₁ [mm]	100	125	160	200	250	315	355	400	450	500	560	630
L [mm]	Cena [PLN/szt.] • Price [PLN/pc]											
300	264,42	272,20	313,92	373,66	481,00	520,05	606,26	864,78	959,89	1 069,79	1 254,79	1 481,17
600	338,61	354,30	414,26	499,36	645,19	712,50	817,84	1 136,76	1 238,33	1 362,36	1 575,94	1 839,68
900	429,05	453,52	534,18	648,42	839,31	937,53	1 172,24	1 365,25	1 576,94	1 722,10	1 975,18	2 290,77
1000	459,31	486,56	574,11	697,92	904,15	1 012,39	1 263,69	1 466,81	1 689,74	1 842,03	2 108,11	2 441,17
1200	517,83	551,31	652,09	793,48	1 028,74	1 153,56	1 436,78	1 656,93	1 898,32	2 065,50	2 352,95	2 717,15



Tłumik elastyczny okrągły • Circular flexible silencer

SLL S-FLEX



Obudowa zewnętrzna wykonana jest z przewodu półelastycznego aluminiowego S-Flex®. Warstwę tłumiącą stanowi wełna mineralna, zabezpieczona od strony instalacji przewodem z perforacją.

External cover made of semi-flexible aluminum duct S-Flex®.

Damping layer of mineral wool secured with perforated aluminum duct.

Izolacja 50 mm • Insulation 50 mm

øD [mm]	80	100	125	150	160	200	250	315
L [mm]	Cena [PLN/szt.] • Price [PLN/pc]							
600	209,80	212,13	230,37	250,73	250,73	319,26	357,97	405,92
900	250,73	259,86	289,56	314,70	317,03	392,23	449,18	508,47
1000	255,30	266,75	296,46	323,82	328,38	403,57	462,87	586,01
1200	289,56	305,58	339,62	371,65	373,87	458,31	522,16	679,45
1500	312,36	337,39	376,22	415,03	417,26	513,04	595,13	740,97

Tłumik elastyczny okrągły • Circular flexible silencer

SLE AF019



øD [mm]	100	125	160	200	250	315
L [mm]	Cena [PLN/szt.] • Price [PLN/pc]					
500	68,04	84,24	116,64	129,60	158,76	197,64
1000	77,76	93,96	129,60	149,04	181,44	226,80



Łącznik półelastyczny • *Semiflexible connector*

DRATMF



øD [mm]	80	100	125	160	200	250	315
L [mm]	Cena [PLN/szt.] • Price [PLN/pc]						
500	56,29	57,74	64,08	79,54	94,11	117,47	152,06
1000	63,85	66,30	76,09	96,23	115,35	148,06	222,15
1500	73,31	79,21	90,10	112,91	141,84	180,32	245,61

Tłumik prostokątny do kanałów okrągłych • *Rectangular silencer*

SLL-R



øD [mm]	100	125	160	200	250	315
L [mm]	Cena [PLN/szt.] • Price [PLN/pc]					
500	162,00	175,00	209,00	216,00	228,00	262,00
1000	186,00	202,00	250,00	284,00	338,00	401,00

Tłumik elastyczny • *Flexible silencers*

TAE

L = 1000 mm



Vent4U

øD [mm]	Cena / opak. • Price / pack. [PLN / m]
83	163,85
102	167,96
127	184,29
152	Z
163	192,61
203	221,17
229	Z

øD [mm]	Cena / opak. • Price / pack. [PLN / m]
254	258,15
305	Z
315	348,24
356	Z
406	438,33
458	Z
508	Z



Tłumik akustyczny płytowy • Rectangular silencer

TAP



Ilość działek • Number of slits	1	2	3	4	5	6	7	8
B [mm]	150-200	300-400	450-600	750-800	900-1000	1050-1200	1350-1400	1500-1600
H [mm]	Cena [PLN/szt.] • Price [PLN/pc]							
Długość tłumika: • Length: L = 600 mm								
300	331,16	560,65	790,14	1 058,78	1 309,19	×	×	×
450	362,53	610,26	865,78	1 126,63	1 389,95	1 658,59	1 942,81	2 065,39
600	401,58	659,76	933,64	1 197,05	1 463,03	1 773,39	2 062,83	2 360,07
900	469,43	764,11	1 077,03	1 337,88	1 635,12	1 942,81	2 253,17	2 579,21
Długość tłumika: • Length: L = 1000 mm								
300	440,40	745,42	1 077,58	1 217,85	1 736,90	×	×	×
450	494,58	831,52	1 185,82	1 577,05	1 901,76	2 219,13	2 534,05	2 841,51
600	555,97	915,17	1 281,82	1 714,77	2 056,83	2 406,12	2 760,43	3 126,96
900	674,11	1 099,72	1 537,67	1 975,62	2 393,78	2 816,93	3 267,23	3 697,73
Długość tłumika: • Length: L = 1250 mm								
300	532,03	857,95	1 191,76	1 603,88	1 914,22	×	×	×
450	612,80	967,50	1 343,04	1 744,66	2 096,76	2 446,14	2 819,09	3 218,12
600	693,69	1 069,24	1 462,97	1 885,45	2 263,60	2 652,13	3 072,03	3 494,51
900	834,48	1 262,15	1 734,17	2 156,65	2 602,62	3 056,45	3 533,65	4 018,64

Możliwość wykonania o indywidualnych wymiarach w zakresie H=300+1500 mm oraz B=300+1500 mm - cena na zapytanie.

• Possible manufacturing within range H=300+1500 mm oraz B=300+1500 mm - price on inquiry.

Obejma do rur zwijanych bez uszczelki • Pipe clip for round ducts without gasket

OPO



øD [mm]	Op. ^{*)}	Cena [PLN/szt.] • Price [PLN/pc]
80	60	15,07
100	100	15,97
125	100	17,00
150	100	17,34
160	60	17,68
180	30	19,15
200	50	20,28
224	30	22,32
250	50	24,02

øD [mm]	Op. ^{*)}	Cena [PLN/szt.] • Price [PLN/pc]
315	50	28,33
355	50	31,83
400	50	35,46
500	10	50,99
560	10	69,80
630	10	69,34
710	10	72,85
800	10	86,00

Obejma do rur zwijanych z uszczelką • Pipe clip for round ducts with gasket

OPOX



øD [mm]	Op. ^{*)}	Cena [PLN/szt.] • Price [PLN/pc]
80	60	19,15
100	100	19,83
125	100	21,98
150	100	24,37
160	60	24,70
180	60	26,51
200	50	28,67
225	30	31,83
250	50	35,46

øD [mm]	Op. ^{*)}	Cena [PLN/szt.] • Price [PLN/pc]
315	50	42,49
355	50	46,00
400	50	49,62
500	10	83,84
560	10	93,36
630	10	113,19
710	10	115,80
800	10	125,76

Obejma kwasoodporna do rur zwijanych z uszczelką EPDM

• Pipe clips for round ducts with EPDM gasket (stainless steel)

OPOX INOX



øD [mm]	Op. ^{*)}	Cena [PLN/szt.] • Price [PLN/pc]
100	150	86,11
125	80	96,07
150	60	104,58
160	60	108,77
180	60	114,43
200	40	124,29
225	40	134,15

øD [mm]	Op. ^{*)}	Cena [PLN/szt.] • Price [PLN/pc]
250	35	139,93
315	40	168,14
355	15	180,83
400	25	197,82
500	5	400,29
630	5	494,56

^{*)} Ilość [szt./opak.] • Quantity [pcs/pack.]

MATERIAŁY MONTAŻOWE

Opaski zaciskowe, taśma do opasek, opaski montażowe

• Band clip, clip tape, supressing bands



Zamek zaciskowy
• *Traction device*

CMC

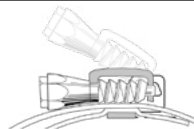

Opakowanie • Package [szt. • pcs]	Cena [PLN/opak.] • Price [PLN/pack.]
50	206,55

Taśma do opasek
• *Tape in coil for band clip*

CMB



Opakowanie • Package [mb]	Cena [PLN/opak.] • Price [PLN/pack.]
30	187,74

Opaska zaciskowa metalowa
• *Metal band clip*

CM



Zakresy średnic • Diameters range øD [mm]	Opak. • Package [szt. • pcs]	Cena [PLN/szt.] • Price [PLN/pc]
60-110	50	7,59
60-135	50	8,61
60-165	50	9,30
60-215	50	10,99
60-270	50	13,94
60-325	50	13,94
60-525	50	17,68
60-660	50	19,37

Opaska zaciskowa nylonowa
• *Nylon band clip*

CMN



Długość • Length L [mm]	Opak. • Package [szt. • pcs]	Cena [PLN/szt.] • Price [PLN/pc]
1188	100	6,01
920	100	4,30
800	100	3,74
650	100	2,95
550	100	2,72

Opaska montażowa • Supressing band

OM

Opaska montażowa przeciwdrganiowa do podwieszania wentylatorów kanałowych okrągłych.

Supressing bands for fan installation in round ducts.



Typ • Type	Średnica • Diameter [mm]	Cena [PLN/szt.] • Price [PLN/pc]
OM 100	100	37,16
OM 125	125	38,75
OM 150	150	40,45
OM 160	160	42,15
OM 200	200	45,55
OM 250	250	48,95
OM 315	315	52,23
OM 355	355	64,02
OM 400	400	70,82
OM 500	500	84,18

Zawiesie ocynkowane L z amortyzatorem

• L type suspension



Opakowanie: 100 szt. • Package: 100 pcs

Zamówienia [szt.] • Order [pcs]	Cena [PLN/szt.] • Price [PLN/pc]
< 100	6,57
100 ÷ 2000	2,84
> 2000	1,47

Zawiesie ocynkowane R/V z amortyzatorem

• R/V type suspension



Opakowanie: 100 szt. • Package: 100 pcs

Zamówienia [szt.] • Order [pcs]	Cena [PLN/szt.] • Price [PLN/pc]
< 100	6,57
100 ÷ 2000	2,84
> 2000	1,47

Zawiesie ocynkowane Z z amortyzatorem

• Z type suspension



Opakowanie: 100 szt. • Package: 100 pcs

Zamówienia [szt.] • Order [pcs]	Cena [PLN/szt.] • Price [PLN/pc]
< 100	6,57
100 ÷ 2000	2,84
> 2000	1,47

Zawiesia ze stali kwasoodpornej L/V/Z z amortyzatorem

• L/V/Z type suspensions (stainless steel)



Opakowanie: 100 szt. • Package: 100 pcs

Typ • Type	Cena [PLN/szt.] • Price [PLN/pc]
L	25,50
V	41,24
Z	25,50

Nakrętka łączna

• Connecting nut

LN



Gwint • Thread	Op. *)	Cena [PLN/szt.] • Price [PLN/pc]
M8	100	1,93
M10	50	2,95

Pręt gwintowany ocynkowany

• Threaded rod (galvanized steel)



Gwint • Thread	Op. ¹⁾	Cena [PLN/szt.] • Price [PLN/pc]	
		1÷300 szt. • pcs	>300 szt. • pcs
L = 1000 m			
M6	25	4,30	1,82
M8	25	6,69	2,61
M10	25	8,50	4,08
L = 2000 m			
M6	50	8,50	3,40
M8	25	13,49	4,87
M10	25	16,76	7,70

Pręt gwintowany ze stali kwasoodpornej

• Threaded rod (stainless steel)

Gwint • Thread	Op. ¹⁾	Cena [PLN/szt.] • Price [PLN/pc]
M8	25	118,97
M10	25	186,95

Uchwyt pręta gwintowanego ocynkowany

• Beam clamp (galvanized steel)

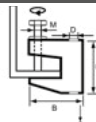

Gwint • Thread	Op. ¹⁾	Cena [PLN/szt.] • Price [PLN/pc]	
		1÷1000 szt. • pcs	>1000 szt. • pcs
M8	100	11,64	2,72
M10	100	11,64	3,63

¹⁾ Ilość [szt./opak.] • Quantity [pcs/pack.]

MATERIAŁY MONTAŻOWE

Konsole kątowe, blachowkręty, tuleje kotwiące

• Consoles, self-drilling screws, anchor bushes



Konsola kątowa typ T

• Console type T



Długość • Length [mm]	Profil • Profile	Cena [PLN/szt.] • Price [PLN/pc]
420	FT30	35,70
510	FT30	40,68
690	FT30	48,95

Konsola kątowa typ T z odkosem

• Console type T with support



Długość • Length [mm]	Profil • Profile	Cena [PLN/szt.] • Price [PLN/pc]
510	FT30	80,55
690	FT30	96,88

Blachowkręt ocynkowany

• Screw (galvanized steel)



Długość • Length [mm]	Op. ¹⁾	Cena [PLN/szt.] • Price [PLN/pc]		
		<5000 szt. • pcs	<20000 szt. • pcs	>20000 szt. • pcs
4,2 × 9,50	1000	151,14	83,16	60,39
4,2 × 13,00	1000	157,94	86,90	63,22
4,2 × 25,00	1000	218,33	119,99	87,35
samowierzące • self-drilling				
4,2 × 9,50	1000	163,15	89,74	65,15
4,2 × 13,00	1000	173,24	90,64	69,22
4,2 × 16,00	1000	181,85	102,99	80,10
4,2 × 25,00	1000	216,40	123,73	90,87
4,2 × 42,00	500	342,85	188,53	137,20
4,8 × 16,00	1000	225,13	136,07	97,44

Tuleja kotwiąca • Anchor bush



Gwint • Thread	Op. ¹⁾	Cena [PLN/szt.] • Price [PLN/pc]	
		1+1000 szt. • pcs	>1000 szt. • pcs
STALOWA • GALVANIZED STEEL			
M8	100	1,82	0,57
M10	100	2,04	1,02
MOSIĘŻNA • BRASS			
M8	100	3,74	1,93
M10	100	8,83	4,76

¹⁾ Ilość [szt./opak.] • Quantity [pcs/pack.]

MATERIAŁY MONTAŻOWE

Zaciski kanału, podstawa profilu, końcówki do blachowkrętów

• Duct clips, profile base, terminals for screws



Zacisk kanału wentylacyjnego ocynkowany

• Ventilation duct clip (galvanized steel)



Opakowanie: 500 szt. • Package: 500 pcs
100 szt. • pcs = 4,8 kg

Grubość • Thickness	Cena [PLN/szt.] • Price [PLN/pc]	
	1+5000 szt. • pcs	>5000 szt. • pcs
2,5 mm	2,84	0,57
3,0 mm	3,29	0,68

Zacisk kanału wentylacyjnego ze stali kwasoodpornej

• Ventilation duct clip (stainless steel)



100 szt. • pcs = 4,8 kg

Cena [PLN/szt.] • Price [PLN/pc]
14,62

Blachowkręt samowierzący ocynkowany

• Self-drilling screw (galvanized steel)

DO WYCZERPANIA ZAPASÓW!



Długość • Length [mm]	Op. ¹⁾	Cena [PLN/szt.] • Price [PLN/pc]		
		<5000 szt. • pcs	<20000 szt. • pcs	>20000 szt. • pcs
4,2 × 16,00	1000	180,38	102,31	79,42
4,8 × 42,00	1000	223,43	135,06	96,65
4,2 × 16,00 „PAN HEAD”	1000	180,38	102,31	79,42
4,2 × 25,00 „PAN HEAD”	1000	214,71	130,87	94,49
4,2 × 42,00 „PAN HEAD”	1000	300,59	188,19	128,82

Podstawa profilu

• Profile base

FT



Cena [PLN/szt.] • Price [PLN/pc]
28,44

Końcówka do blachowkrętów

• Terminal for screws



Typ • Type	Op. ¹⁾	Cena [PLN/opak.] • Price [PLN/pack.]
7 mm	1	21,19
8 mm	1	21,19
„PAN HEAD”	1	7,59

¹⁾ Ilość [szt./opak.] • Quantity [pcs/pack.]

MATERIAŁY MONTAŻOWE

Silikon, uszczelki, śruby dwugwintowe, pianka montażowa

• *Silicon, self-adhesive seals, double-threaded screws, assembly foam*



Silikon

• *Silicon*



Typ • Type	Pojemność • Capacity	Cena [PLN/szt.] • Price [PLN/pc]
Szary akrylowy • <i>Acrylic</i>	310 ml	19,03
Ogniochronny • <i>Fire retardant</i>	300 ml	103,10

Śruba dwugwintowa

• *Double-threaded screw*

VDF



Typ • Type	Opak. [szt.] • Package [pcs]	Cena [PLN/opak.] • Price [PLN/pack.]
M8 × 100	100	98,80
M8 × 120	100	114,54
M10 × 100	100	165,65

Śruba ocynkowana

• *Screw (galvanized steel)*

BB



Typ • Type	Op ^o	Waga • Weight [kg]	Cena [PLN/opak.] • Price [PLN/pack.]
M8 × 25	1000	12,5	543,05

Pianka montażowa

• *Assembly foam*

PE



Pojemność • Capacity	Cena [PLN/szt.] • Price [PLN/pc]
700 ml	52,35

Uszczelka wysokotemperaturowa

• *Temperature resistant seal*

PEST



Rozmiar • Size	Opakowanie [mb] • Package [m]	Cena [PLN/mb] • Price [PLN/m]
10 × 4	10	3,29
10 × 5	10	3,97
10 × 6	10	4,64

Uszczelka

• *Self-adhesive seal*

PES

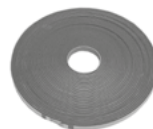

Rozmiar • Size	Opak. [mb] • Pack. [m]	Karton [mb] • Carton [m]	Cena [PLN/mb] • Price [PLN/m]
15 × 6	37,5	750	1,76
15 × 4	60	1200	1,02
12 × 6	50	1000	1,47
10 × 4	100	1000	0,90
10 × 7	50	900	1,36

MATERIAŁY MONTAŻOWE

Śruby, nakrętki, taśmy perforowane, podkładki

• Screws, nuts, perforates suspension banding, washers



Nakrętka ocynkowana

• Nut (galvanized steel)

NN



Gwint • Thread	Op ¹⁾	Waga • Weight [kg]	Cena [PLN/opak.] • Price [PLN/pack.]
M6	1000	2,0	88,72
M8	1000	4,5	177,65
M10	1000	10,0	389,41

Nakrętka ze stali kwasoodpornej

• Nut (stainless steel)

**NN
INOX**



Gwint • Thread	Op ¹⁾	Waga • Weight [kg]	Cena [PLN/opak.] • Price [PLN/pack.]
M8	1000	4,5	1 213,67

Taśma perforowana

• Perforated suspension banding

DUH



Typ • Type	Opakowanie [mb] • Package [m]	Cena [PLN/opak.] • Price [PLN/pack.]
0,6 × 17	25	100,61
0,6 × 25	25	149,79

Podkładka ocynkowana

• Washer (galvanized steel)

WW



Gwint • Thread	Op ¹⁾	Waga • Weight [kg]	Cena [PLN/opak.] • Price [PLN/pack.]
M6	1000	5,0	225,58
M8	1000	5,5	244,84
M10	1000	6,0	254,58

Guma amortyzująca

• Shock absorbing rubber

RU-25



Cena [PLN/mb] • Price [PLN/m]
13,37

Gumki amortyzacyjne

• Cushioning rubbers



Cena [PLN/szt.] • Price [PLN/pc]
1,36

¹⁾ Ilość [szt./opak.] • Quantity [pcs/pack.]

Kształtownik montażowy • Support channel

W

W 18

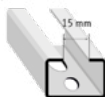

L [m]	Wymiary [mm] • Dimensions [mm]	Cena [PLN/szt.] • Price [PLN/pc]
2	18×27×1,25	45,77
5		114,54

W 2

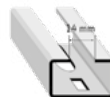

L [m]	Wymiary [mm] • Dimensions [mm]	Cena [PLN/szt.] • Price [PLN/pc]
2	20×34×2,0	56,09
5		140,04

W 105

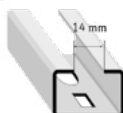

L [m]	Wymiary [mm] • Dimensions [mm]	Cena [PLN/szt.] • Price [PLN/pc]
2	20×30×1,5	50,88
3		76,40
5		127,35

W 106



L [m]	Wymiary [mm] • Dimensions [mm]	Cena [PLN/szt.] • Price [PLN/pc]
2	30×30×1,5	67,64
3		103,39
5		172,33

W 107



L [m]	Wymiary [mm] • Dimensions [mm]	Cena [PLN/szt.] • Price [PLN/pc]
2	43×30×1,7	110,13
5		269,42

W 41



L [m]	Wymiary [mm] • Dimensions [mm]	Cena [PLN/szt.] • Price [PLN/pc]
5	41×41×1,8	337,40
5	41×41×2,5	445,04
6		533,87



SolidFoot H Frame Kit

Uniwersalne stopy wspornikowe łączone kształtownikami 41×41 mm.

• Universal feet connected by support channel 41×41 mm.

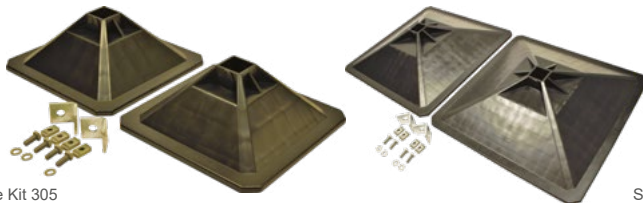

SolidFoot H Frame Kit 305

SolidFoot H Frame Kit 500

Typ • Type	Wymiar stopy • Feet [mm]	S.W.L. zestawu • Max S.W.L [kg]	Cena [PLN/opak.] • Price [PLN/pack.]
SolidFoot H Frame Kit 305	305×305	350	306,00
SolidFoot H Frame Kit 500	500×500	500	703,00

SolidFoot Fix

Antywibracyjne podstawy do montażu małych urządzeń.

• Anti-vibration base for small units.



Typ • Type	Wymiary • Dimensions [mm]	Maks. udźwign na szt. • Max load / pc [kg]	Cena [PLN/szt.] • Price [PLN/pc]
SolidFoot Fix 250*	250×180×95	160	85,00
SolidFoot Fix 400	400×180×95	240	94,00
SolidFoot Fix 600	600×180×95	450	140,00
SolidFoot Fix 1000*	1000×180×95	645	299,00
SolidFoot Fix 250L*	250×130×50	160	79,00
SolidFoot Fix 400L*	400×130×50	240	95,00

* Na zamówienie • On request



SolidFoot Mini Base / Plus



SolidFoot Mini Base

Typ - Type	Wymiary - Dimensions [mm]	Maks. udźwig - Max load [kg]	Cena [PLN/kpl.] - Price [PLN/set]
SolidFoot Mini Base	800×800	300	1 365,00
SolidFoot Mini Plus	800×800	260	1 092,00

SolidFoot Base / Plus

Modułowe ramy wspornikowe. - Modular frames.



SolidFoot Base



SolidFoot Plus

Typ - Type	Wymiary - Dimensions [mm]	Maks. udźwig - Max load [kg]	Cena [PLN/kpl.] - Price [PLN/set]
SolidFoot Base	1000×1200	700	2 122,00
	1000×1500	700	2 736,00
SolidFoot Plus	1000×1200	350	1 239,00
	1000×1500	350	1 741,00

Przykładowa konfiguracja:

Modułowa konstrukcja umożliwiająca tworzenie własnej konfiguracji poprzez dołączanie kolejnych segmentów Plus do ramy podstawowej Base.

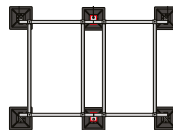

SolidFoot Base + SolidFoot Plus

*) Na zamówienie - On request



SolidFoot Beam*

Kompletny zestaw wspornikowy z szeroką gamą zastosowań.

* Complete support set.

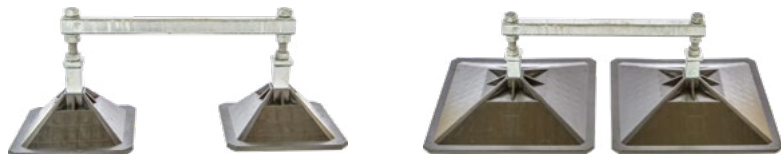

SolidFoot Beam 305

SolidFoot Beam 500

Typ - Type	Wymiar stopy - Feet [mm]	S.W.L. zestawu - Max S.W.L. [kg]	Cena [PLN/kpl.] * Price [PLN/set]
SolidFoot Beam 305	305×305	350	1 040,00
SolidFoot Beam 500	500×500	500	1 190,00

SolidFoot Platform*

Modułowe platformy techniczne. * Modular technical platform.



Typ - Type	Wymiary - Dimensions [mm]	Cena [PLN/szt.] * Price [PLN/pc]
SolidFoot Platform	1000×1000	3 896,00
SolidFoot Platform - 1 Step	1000×1000	15 173,00
SolidFoot Platform - 2 Step	1000×1000	17 644,00
SolidFoot Platform - 3 Step	1000×1000	19 882,00
SolidFoot Platform - 4 Step	1000×1000	22 010,00

*) Na zamówienie - On request



SolidFoot Mat*

Podkładki antywibracyjne. • *Anti-vibration pads.*

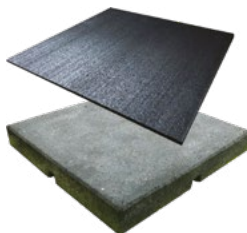

Typ • Type	Cena [PLN/szt.] • Price [PLN/pc]
SolidFoot VibroMat 330H (45mm)	107,00
SolidFoot VibroMat 500H (45mm)	144,00
SolidFoot AV Pads 300L (6mm)	72,00
SolidFoot AV Pads 500L (6mm)	91,00

Typ • Type	Cena [PLN/szt.] • Price [PLN/pc]
SolidFoot Angled Pads 305 2.5°	108,00
SolidFoot Angled Pads 500 2.5°	125,00
SolidFoot Angled Pads 305 5°	108,00
SolidFoot Angled Pads 500 5°	125,00

SolidFoot Quad*

System wspornikowy do montażu ciężkich urządzeń HVAC na dachach płaskich.

• *Support systems for heavy duty units.*



Typ • Type	Wymiary • Dimensions [mm]	Cena [PLN/szt.] • Price [PLN/pc]
SolidFoot Quad 305	305×305	1 487,00
SolidFoot Quad 500	500×500	2 602,00

SolidFoot DA*

Podstawa do przewodów z regulacją wysokości.

• *Duct adjuster*



Typ • Type	Wymiary • Dimensions [mm]	Cena [PLN/szt.] • Price [PLN/pc]
SolidFoot DA 305	305×305	1 289,00
SolidFoot DA 500	500×500	787,00

* Na zamówienie • *On request*

Profil kanałowy ocynkowany
• Ductwork profile (galvanized steel)

DW

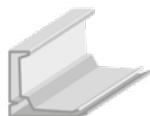

Typ • Type	Długość [mb] • Length [m]	Cena [PLN/mb] • Price [PLN/m]	
		1-5000 m	> 5000 m
DW-20	3	9,86	3,97
	5		
DW-30	3	11,90	5,32
	5		
DW-40	3	17,11	11,33
	5		

Narożnik ocynkowany do profili kanałowych
• Corner (galvanized steel)

H

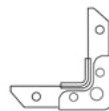

Typ • Type	Opak. [szt.] • Pack. [pcs]	Cena [PLN/szt.] • Price [PLN/pc]	
		1-5000 szt. • pc	> 5000 szt. • pc
H-20	1	1,71	0,57
H-20 KRÓTKI	1	1,58	0,57
H-20 DŁUGI	1	2,04	0,79
H-30	1	3,40	1,58
H-40	1	6,91	3,29

Profil kanałowy - stal kwasoodporna
• Ductwork profile (stainless steel)

**DW
INOX**



Typ • Type	Długość [mb] • Length [m]	Cena [PLN/mb] • Price [PLN/m]
DW-20 INOX*	5	115,80
DW-30 INOX*	5	147,86

Narożnik ze stali kwasoodpornej do profili kanałowych
• Corner (stainless steel)

**H
INOX**



Typ • Type	Opak. [szt.] • Pack. [pcs]	Cena [PLN/szt.] • Price [PLN/pc]
H-20 INOX*	1	18,13
H-30 INOX*	1	39,66

* Do zamówień powyżej 500 mb oferujemy duże rabaty • For orders above 500 meters we offer large discounts.

MATERIAŁY PRODUKCYJNE

Siatka, rurka usztywniająca, dysk/krzyżak usztywniający, cynk w sprayu

• Mesh, stiffening aluminium pipe, stiffening disc and cross, Alu-Zinc spray



Siatka ocynkowana 12×12

• Galvanized steel 12x12 mesh



Rolka • Roll [m ²]	Cena [PLN/m ²] • Price [PLN/m ²]
15	84,74

Rurka usztywniająca aluminiowa

• Stiffening aluminium pipe

RUO



Wymiary • Dimensions [mm]	Cena [PLN/mb] • Price [PLN/m]
16 × 6000	26,17

Dysk usztywniający

• Stiffening disc

DU



Opakowanie [szt.] • Package [pcs]	Cena [PLN/opak.] • Price [PLN/-pack.]
1000	1 403,23

Krzyżak usztywniający stalowy

• Stiffening steel cross

KUS



Opakowanie [szt.] • Package [pcs]	Cena [PLN/mb] • Price [PLN/m]
100	581,00

Spray cynkowy Alucynk

• Alu-Zinc spray

AlZn
600



Opakowanie • Package [ml]	Cena [PLN/m ²] • Price [PLN/m ²]
500	67,87

Masa uszczelniająca CARJOINT

• "CARJOINT" tightening compound



Opakowanie • Package [ml]	Cena [PLN/mb] • Price [PLN/m]
310	35,75

Mechanizm przepustnicy SPIRO

• SPIRO damper mechanism



Typ • Type	Opak. [szt.] • Package [pcs]	Cena [PLN/szt.] • Price [PLN/pc]
SPIRO	1	22,77

Łącznik elastyczny

• Flexible connector

LE



Typ • Type	Opak. • Pack. [m]	Cena [PLN/opak.] • Price [PLN/pack.]
XEV-50 PVC 35/60/35	50	1 156,45
KEV-50 PVC 45/60/45	50	1 191,36
EEV-100 PVC 70/100/70	50	1 025,26

Mechanizm przepustnicy

• Damper mechanism

KS



Typ • Type	Opak. [szt.] • Package [pcs]	Cena [PLN/szt.] • Price [PLN/pc]
KS 145	1	8,50
KS 385 zestaw • set	1	22,66

Mechanizm przepustnicy

• Damper mechanism

MD

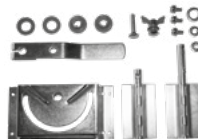

Typ • Type	Opak. [szt.] • Package [pcs]	Cena [PLN/szt.] • Price [PLN/pc]
MD	1	31,16

Mechanizm przepustnicy

• Damper mechanism

KSR

195



Typ • Type	Opak. [szt.] • Package [pcs]	Cena [PLN/szt.] • Price [PLN/pc]
KSR 195 zestaw • set	1	14,17

Rączka mechaniczna przepustnicy

• Damper hand



Cena [PLN/szt.] • Price [PLN/pc]
9,41

MATERIAŁY PRODUKCYJNE

Trzpień, masy uszczelniające, kołnierze

• Bolts, tightening compound, flanges



Trzpień mechanizmu przepustnicy

• Damper bolts



Typ - Type	Cena [PLN/szt.] • Price [PLN/pc]
BKP7	18,50

Masa uszczelniająca

• Tightening compound

DW 601



Opakowanie [kg] • Package [kg]	Cena [PLN/opak.] • Price [PLN/pack.]
6	421,48

Łącznik kierownicy kolana wentylacyjnego

• Turning vane guide for rectangular duct

LKK



Opakowanie [szt.] • Package [pcs]	Cena [PLN/opak.] • Price [PLN/pack.]
100	156,01

Nit aluminiowo-stalowy

• Aluminum-steel rivets



Typ - Type	Opak. [szt.] • Package [pcs]	Cena [PLN/opak.] • Price [PLN/pack.]
39/06	1000	148,19
39/08	1000	153,53

Kołnierz - Flange

VKPK



Średnica - Diameter D [mm]	Cena [PLN/szt.] • Price [PLN/pc]
80	45,55
100	32,75
110	49,29
125	38,86
140	55,07
150	59,15
160	41,69
180	62,21
200	44,98
224	66,62
250	62,43
315	68,88
355	82,37
400	101,52
500	143,10
560	171,77
630	200,77

Przepustnica wielopłaszczyznowa aluminiowa • Aluminium multi-leaf damper

PWT

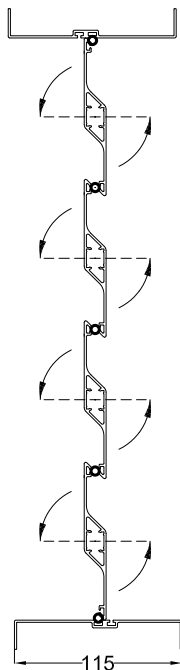
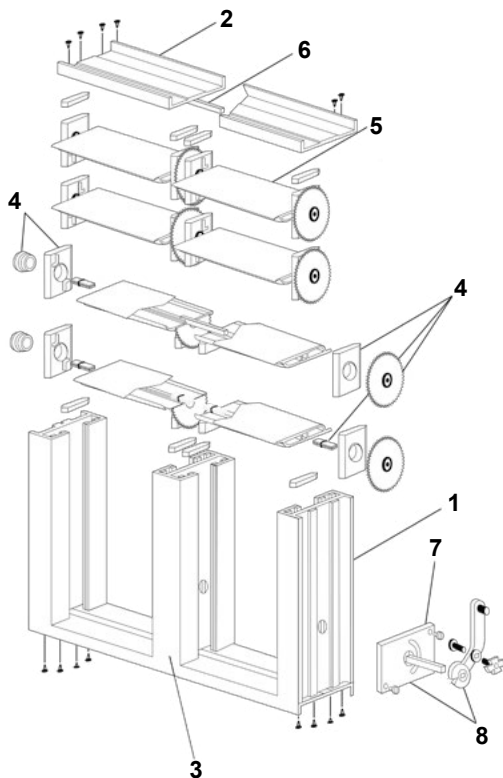

1	PBP-120	Profil lewy-prawy, długość 5,8 m • <i>Left-right profile, length 5,8 m</i>	113,98 PLN/mb
2	PGP-110	Profil górny-dolny, długość 5,8 m • <i>Upper-bottom profile, length 5,8 m</i>	68,77 PLN/mb
3	PSP-130	Profil środkowy, długość 5,8 m • <i>Central profile, length 5,8 m</i>	168,71 PLN/mb
4	CPS 2007	Mechanizm koła zębatego • <i>Mechanism</i>	37,28 PLN/kpl. • <i>set</i>
5	PPP-100	Pióro przepustnicy, długość 5,8 m • <i>Damper blade, length 5,8 m</i>	137,78 PLN/mb
6	GA12T	Uszczelka • <i>Gasket</i>	5,43 PLN/mb
7	BKP7	Trzpień • <i>Pivot</i>	18,50 PLN/szt. • <i>pc</i>
8	RDP	Rączka mechaniczna przepustnicy • <i>Damper hand</i>	11,22 PLN/kpl. • <i>set</i>

Przepustnica wielopłaszczyznowa aluminiowa • Aluminium multi-leaf damper

PW

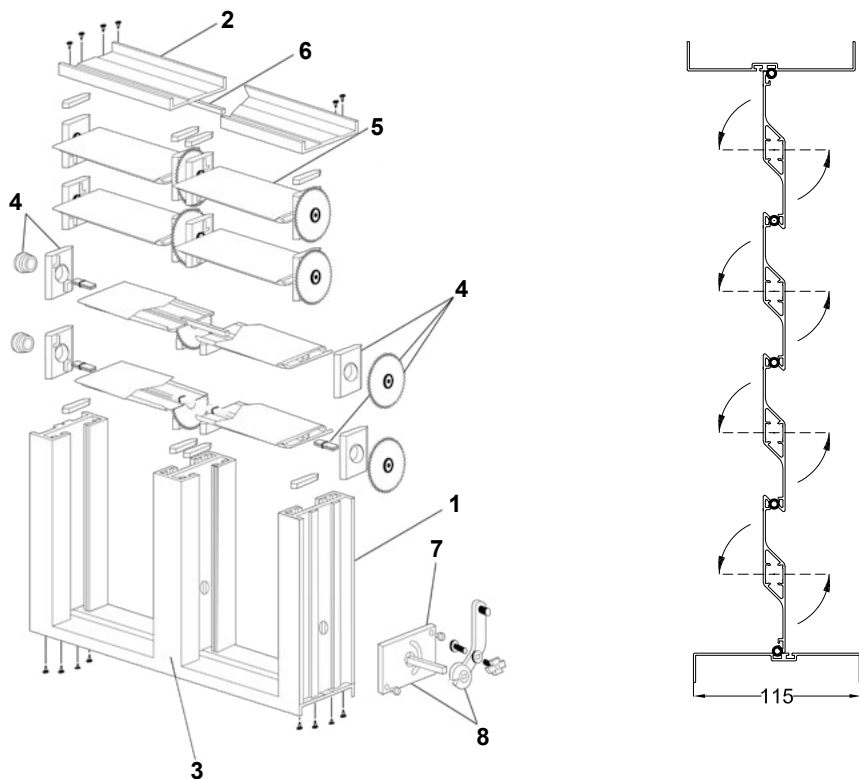

1	PBP-120	Profil lewy-prawy, długość 5,8 m • <i>Left-right profile, length 5,8 m</i>	113,98 PLN/mb
2	PGP-110	Profil górny-dolny, długość 5,8 m • <i>Upper-bottom profile, length 5,8 m</i>	68,77 PLN/mb
3	PSP-130	Profil środkowy, długość 5,8 m • <i>Central profile, length 5,8 m</i>	168,71 PLN/mb
4	CPS 93	Mechanizm koła zębatego • <i>Mechanism</i>	30,36 PLN/kpl. • <i>set</i>
5	PPP-100	Pióro przepustnicy, długość 5,8 m • <i>Damper blade, length 5,8 m</i>	137,78 PLN/mb
6	GA12T	Uszczelka • <i>Gasket</i>	5,43 PLN/mb
7	BKP7	Trzpień • <i>Pivot</i>	18,50 PLN/szt. • <i>pc</i>
8	RDP	Rączka mechaniczna przepustnicy • <i>Damper hand</i>	11,22 PLN/kpl. • <i>set</i>

Czerpnia/wyrzutnia prostokątna aluminiowa

• Aluminium rectangular air intake/exhauster

CWA

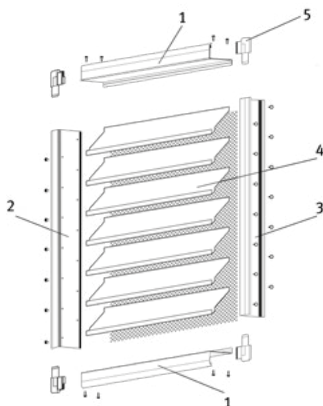

1	PGC-BA	Profil górny-dolny, długość 5,8 m • Upper-bottom profile, length 5,8 m	55,52 PLN/mb
2/3	PBC-SS/SD	Profil lewy/prawy, długość 5,8 m • Left profile, length 5,8 m	127,92 PLN/mb
4	PLC-PA	Lamela, długość 5,8 m • Louvre, length 5,8 m	41,13 PLN/mb
5	AZ-GR S	Narożnik lewy-prawy • Left-right corner	51,78 PLN/2szt. • 2pcs

Czerpnia/wyrzutnia prostokątna stalowa ocynkowana

• Rectangular air intake/exhauster, galvanized steel

CW

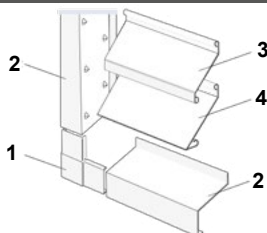

1	BR 40	Narożnik • Corner	4,64 PLN/szt. • pc
2	BR 40/62	Profil ramy, długość 5 m • Frame profile, length 5 m	30,25 PLN/mb
3	LP 66	Profil lameli czerpni, długość 5 m • Louvre profile, length 5 m	21,98 PLN/mb
4	LP 88	Profil lameli okapnika, długość 5 m • Drip louvre profile, length 5 m	31,38 PLN/mb

Przepustnica samoczynna aluminiowa kanałowa/ścienna

• Duct and wall automatic aluminium dampers

PSK / PSS

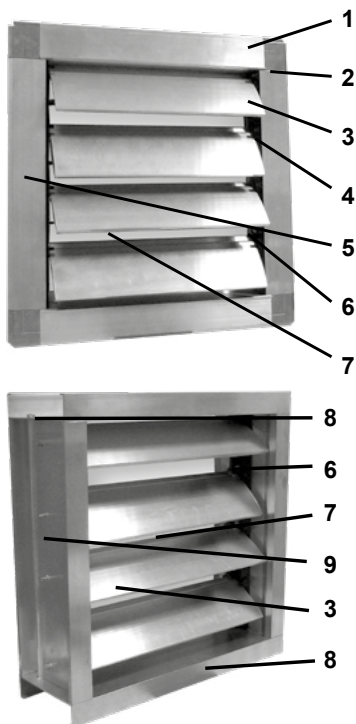

1	PGC-BA	Profil górny-dolny, długość 5,8 m • Upper-bottom profile, length 5,8 m	49,85	PLN/mb
2	AZ-GR S	Narożnik lewy-prawy • Left-right corner	51,78	PLN/mb
3	PK-ALU	Lamela żaluzji • Shutter louvre	67,19	PLN/mb
4/5	PBC-SS/SD	Profil lewy/prawy, długość 5,8 m • Right profile, length 5,8 m	115,01	PLN/mb
6	FK-ALU	Ramka • Frame	63,34	PLN/szt. • pc
7		Uszczelka • Gasket	4,53	PLN/mb
8	PBP-120	Profil górny-dolny, długość 5,8 m • Upper-bottom profile, length 5,8 m	113,98	PLN/mb
9	PGP-110	Profil lewy-prawy, długość 5,8 m • Left-right profile, length 5,8 m	68,77	PLN/mb



VENTwool to maty lamelowe wykonane z wełny mineralnej pokrytej zbrojoną folią aluminiową. Wszystkie produkty dostępne w ramach tej nowej marki zostały od podstaw zaprojektowane z myślą o optymalnej izolacji termicznej przewodniczących wentylacyjnych i urządzeń HVAC. Produkt jest dostępny również w wersji z warstwą samoprzylepną (**VENTwool Plus**).

Szerokość rolki: 1000 mm

Gęstość: 35 kg/m³

Współczynnik przewodnictwa ciepła λ (10°C): 0,038

Zgodność z normą: PN-EN 14303+A1:2013-07

VENTwool are lamella mats made of mineral wool covered with reinforced aluminum foil. All products available under this new brand have been designed for optimal thermal insulation of ventilation ducts and HVAC devices. The product is also available in a version with a self-adhesive layer (VENTwool Plus).

Roll width: 1000 mm

Density: 35 kg/m³

Thermal conductivity λ (10 °C): 0.038

Compliance with the norm: PN-EN 14303 + A1: 2013-07

VENTWOOL

Grubość • Thickness [mm]	Cena [PLN/m ²] • Price [PLN/m ²]
20	16,20
30	18,70
40	22,50
50	26,50
80	39,10
100	50,20

VENTWOOL PLUS

Grubość • Thickness [mm]	Cena [PLN/m ²] • Price [PLN/m ²]
20	28,20
30	31,50
40	39,10
50	44,40
80	59,10
100	68,20



ALU LAMELLA MAT



Maty LAMELLA MAT przeznaczone są do izolacji termicznej oraz przeciwkondensacyjnej kanałów wentylacyjnych i klimatyzacyjnych. Stosowane są również jako izolacja niskotemperaturowych rur, rurociągów, etc.

Gęstość: 36 kg/m³

Grubość • Thickness [mm]	Cena [PLN/m ²] • Price [PLN/m ²]
20	13,20
30	15,44
40	18,62
50	21,87
60	29,58
80	31,20
100	41,59

CONLIT 150 P

Gęstość: 165 kg/m³



Grubość • Thickness [mm]	Cena [PLN/m ²] • Price [PLN/m ²]
20	48,24
30	56,23
40	69,58
50	77,29
60	104,53
80	144,67
100	167,15
120	204,52
150	250,91

KLIMAFIX



Mata KLIMAFIX przeznaczona jest do izolacji termicznej, akustycznej i przeciwkondensacyjnej kanałów wentylacyjnych i klimatyzacyjnych o dowolnym przekroju np. prostokątnym, kołowym itp. Użycie maty KLIMAFIX pomaga skrócić czas montażu izolacji nawet do 40%.

Grubość • Thickness [mm]	Cena [PLN/m ²] • Price [PLN/m ²]
20	26,46
30	28,64
40	35,65
50	40,67

CONLIT PLUS 60 ALU



Klasa zabezp.	Grubość • Thickness [mm]	Cena [PLN/m ²] • Price [PLN/m ²]
EIS 30 / EIS 60	60	162,72
EIS 90 / EIS 120	60	239,51

SILKROCK



Grubość • Thickness [mm]	Cena [PLN/m ²] • Price [PLN/m ²]
50	56,50
100	85,00



INDUSTRIAL BATTS BLACK

Płyty INDUSTRIAL BATTS BLACK przeznaczone są do izolacji termicznej i akustycznej kanałów wentylacyjnych na powierzchniach wewnętrznych. Mają również zastosowanie jako izolacja akustyczna tłumików szczelinowych i komorowych oraz ekranów dźwiękochłonnych.

INDUSTRIAL BATTS BLACK are applicable to thermal and acoustic insulation of inside surfaces. They are also applicable for acoustic insulation of silencers and for attenuating screens.



Grubość • Thickness [mm]	Długość/szerokość • Length/width [mm]		
	2000/1200	2000/1200	2000/1200
	60 kg/m ³	60 kg/m ³ PODWÓJNY WIELON • DUAL-LAYER VEIL	80 kg/m ³
Cena [PLN/m ²] • Price [PLN/m ²]			
15	x	x	36,42
20	x	x	38,97
30	41,86	x	x
50	46,78	56,00	x
100	73,06	87,85	x

Pełna oferta izolacji technicznych ROCKWOOL - na zapytanie.

Gwoździe samoprzylepne • Self-adhesive nails

GS

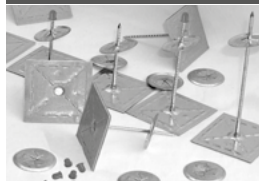

Gwoździe samoprzylepne służą do mechanicznego zamocowania materiałów izolacyjnych na gładkiej powierzchni przewodów wentylacyjnych. Zastosowanie w zakresie temperatury od -40°C do $+80^{\circ}\text{C}$ (w krótkim czasie do 100°C).

Self-adhesive nails are used for the mechanical fastening of the insulation materials at the smooth surface of the ventilation ducts. Usage in the temperature range from -40°C to $+80^{\circ}\text{C}$ (and in the very short time also to 100°C).

Typ • Type	Opakowanie [szt.] • Package [pcs]	Cena [PLN/opak.] • Price [PLN/pack.]
Gwoździe samoprzylepne z blaszkami - 32 mm • Self-adhesive nails with plates - 32 mm	100	76,25
Gwoździe samoprzylepne z blaszkami - 44 mm • Self-adhesive nails with plates - 44 mm	100	79,99
Gwoździe samoprzylepne z blaszkami - 51 mm • Self-adhesive nails with plates - 51 mm	100	88,95
Gwoździe samoprzylepne z blaszkami - 63 mm • Self-adhesive nails with plates - 63 mm	100	94,94
Gwoździe samoprzylepne z blaszkami - 114 mm • Self-adhesive nails with plates - 114 mm	100	120,78

MATERIAŁY IZOLACYJNE

Taśmy, mata termoizolacyjna samoprzylepna MST

• Tapes, thermal insulation adhesive mat MST



Taśma aluminiowa izolacyjna

• Insulating aluminium tape



Wielkość • Size [mm]	Cena [PLN/szt.] • Price [PLN/pc]
100 mm × 50 m	80,67
75 mm × 50 m	57,67
50 mm × 50 m	37,50

Taśma aluminiowa izolacyjna zbrojona

• Reinforced insulating aluminium tape

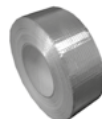

Wielkość • Size [mm]	Cena [PLN/szt.] • Price [PLN/pc]
100 mm × 50 m	100,95
75 mm × 50 m	81,11
50 mm × 50 m	51,94

Taśma uniwersalna naprawcza

• Universal repair tape



Wielkość • Size [mm]	Cena [PLN/szt.] • Price [PLN/pc]
50 mm × 50 m	35,70

Taśma montażowa PVC gładka

• PVC smooth assembling tape

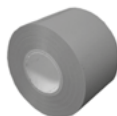

Wielkość • Size [mm]	Cena [PLN/szt.] • Price [PLN/pc]
50 mm × 50 m	28,22

Taśma metalizowana PP

• PP metalized tape

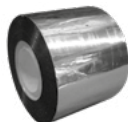

Wielkość • Size [mm]	Cena [PLN/szt.] • Price [PLN/pc]
75 mm × 50 m	35,57
50 mm × 50 m	24,02

Mata termoizolacyjna samoprzylepna

• Thermal insulation adhesive mat

MST

Maty termoizolacyjne samoprzylepne MST wykonane z syntetycznej pianki kauczukowej zwijane w role o szerokości 1 m. Służą do izolowania termicznego oraz ochrony przeciwkondensacyjnej dużych przekrojów rur, zbiorników oraz wszelkiego typu armatury w instalacjach chłodniczych, klimatyzacyjnych, wentylacyjnych, grzewczych, sanitarnych, oraz instalacjach specjalnych.

Thermal insulation sticky MST mats are made of synthetic rubber foam and rolled into 1 m broad rolls. The mats are used for thermal insulation and anti-condensation protection of big diameter pipes, tanks and all types of fixtures in cooling systems, air conditioning systems, heating systems, sanitary and special purpose installations

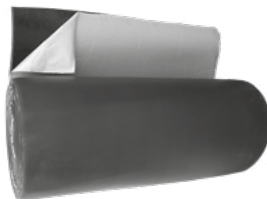

Grubość • Thickness [mm]	Szerokość • Width [m]	Opakowanie • Package [m ² /rolka • roll]	Cena • Price [PLN/m ²]
6	1	10	97,67
9	1	10	113,07
13	1	10	133,69
19	1	10	161,91
25	1	10	223,31

Zawór wyciągowy

• Exhaust air valve

SR-E

Teraz również

w kolorze

RAL 9003!



Zawór nawiewny

• Supply air valve

SR-S

Teraz również

w kolorze

RAL 9003!



øD [mm]	Op. ^{*)}	Cena katalogowa	Zakup > 500 szt. ^{**)}
		• Basic price	• Order > 500 pcs ^{*)}
[PLN/szt.] • [PLN/pc]			
80	7	44,19	6,80
100	7	46,56	7,37
125	7	55,75	10,09
150	7	83,61	13,94
160	7	88,26	15,30
200	7	111,49	19,71
250	7	174,48	33,65

øD [mm]	Op. ^{*)}	Cena katalogowa	Zakup > 500 szt. ^{**)}
		• Basic price	• Order > 500 pcs ^{*)}
[PLN/szt.] • [PLN/pc]			
80	7	44,19	6,80
100	7	46,56	7,37
125	7	55,75	10,09
150	7	83,61	13,94
160	7	88,26	15,30
200	7	111,49	19,71
250	7	174,48	33,65

Zawór wyciągowy z uszczelką

• Exhaust air valve with gasket

SR-EX



øD [mm]	Cena katalogowa [PLN/szt.]
	• Basic price [PLN/pc]
100	81,47
125	108,32
160	144,79
200	194,65

Zawór nawiewny z uszczelką

• Supply air valve with gasket

SR-SX



øD [mm]	Cena katalogowa [PLN/szt.]
	• Basic price [PLN/pc]
100	81,69
125	108,32
160	140,26

^{*)} Ilość [szt./opak.] • Quantity [pcs/pack.]

^{**)} Rabatu za wielkość zamówienia nie można łączyć z innymi rabatami lub promocjami
• Discount for quantity of pieces ordered cannot be added to any other discount

Zawór wyciągowy

• Exhaust air valve

SF-E

øD [mm]	Op. ^{*)}	Cena katalogowa	Zakup > 60 szt. ^{**)}
		• Basic price	• Order > 60 pcs ^{**)}
		[PLN/szt.]	• [PLN/pc]
100	7	43,16	26,17
125	7	53,82	32,63
160	7	77,50	47,03
200	7	99,81	60,50
Wersja z ramką SF-EF			
100	7	51,89	31,38
125	7	64,47	39,09

Zawór nawiewny

• Supply air valve

SF-S

øD [mm]	Op. ^{*)}	Cena katalogowa	Zakup > 60 szt. ^{**)}
		• Basic price	• Order > 60 pcs ^{**)}
		[PLN/szt.]	• [PLN/pc]
100	7	54,49	30,93
125	7	69,11	39,31
160	7	92,57	52,46
200	7	119,54	67,30
Wersja z ramką SF-SF			
100	7	65,48	37,16
125	7	82,94	47,14

Zawór wyciągowy ze stali kwasoodpornej

• Exhaust air valve (stainless steel)

EV-S

øD [mm]	Op. ^{*)}	Cena [PLN/szt.]
		• Price [PLN/pc]
100	7	88,83
125	7	107,98
160	7	177,09
200	7	291,52

Zawór nawiewny ze stali kwasoodpornej

• Supply air valve (stainless steel)

SV-S

øD [mm]	Op. ^{*)}	Cena [PLN/szt.]
		• Price [PLN/pc]
100	7	88,83
125	7	107,98
160	7	177,09
200	7	291,52

*) Ilość [szt./opak.] • Quantity [pcs/pack.]

**) Rabatu za wielkość zamówienia nie można łączyć z innymi rabatami lub promocjami
• Discount for quantity of pieces ordered cannot be added to any other discount

Zawór nawiewno-wywiewny

• Plastic air valve

VP



øD [mm]	Op. ^{*)}	Cena katalogowa • Basic price	Zakup > 500 szt. ^{**)} • Order > 500 pcs ^{*)}
		[PLN/szt.]	[PLN/pc]
125	7	23,00	8,83
150	7	27,53	10,09
160	7	41,13	14,39
200	7	54,84	21,19

Zawór nawiewno-wywiewny ze stali chromowo-niklowej

• Air valve VS (CrNi steel)

VS



øD [mm]	Op. ^{*)}	Cena [PLN/szt.] • Price [PLN/pc]
100	7	94,38
125	7	114,66
150	7	135,40
160	7	158,62
200	7	352,59

Zawór przeciwpożarowy • Fire valve

MCR ZIPP

øD [mm]	Cena [PLN/szt.] • Price [PLN/pc]
100	404,00
125	433,00

øD [mm]	Cena [PLN/szt.] • Price [PLN/pc]
160	494,00
200	542,00



Wersja RST, sprężyna z topikiem.
Inne wersje na zapytanie.

*) Ilość [szt./opak.] • Quantity [pcs/pack.]

**) Rabatu za wielkość zamówienia nie można łączyć z innymi rabatami lub promocjami
• Discount for quantity of pieces ordered cannot be added to any other discount

Anemostat okrągły z przepustnicą • Circular diffuser with damper

DS



- materiał: aluminium, stal ocynkowana
- zintegrowana przepustnica wykonana z tw. sztucznego
- malowane proszkowo na kolor biały (RAL 9016)
- lekka waga nawet przy dużym gabarycie
- do nawiewu/wywiewu ciepłego/zimnego powietrza
- odpowiedni do systemów o zmiennej ilości powietrza

- material: aluminium, galvanized steel
- integrated damper made of plastic
- powder painted white (RAL 9016)
- light weight even in case of large size
- for hot or cold air supply/exhaust
- appropriate for systems with variable air volume

Wymiar • Size [mm]	øA [mm]	øD [mm]	øH [mm]	Cena [PLN/szt.] • Price [PLN/pc]
150	257	145	225	156,93
200	309	197	275	173,46
250	357	248	325	231,13
300	418	294	388	318,03
350	474	348	444	430,43

Anemostat sufitowy kwadratowy • Rectangular ceiling diffuser

HB40



- wykonane z tłoczonego aluminium
- malowane proszkowo na kolor biały (RAL 9010)
- nachylenie kierownic strugi 30°
- nawiew czterokierunkowy
- odpowiedni do nawiewu/wywiewu ciepłego lub zimnego powietrza
- lekka waga nawet przy dużym gabarycie

- made of pressed aluminum
- powder painted white (RAL 9016/9010)
- directional lamellas set at 30° angle
- air flow in four directions
- good for hot or cold air supply/exhaust
- light weight even large size

Teraz również w kolorze
RAL 9003!

Wymiar • Size [mm]	Przyłącze • Connection L × H [mm]	Cena [PLN/szt.] • Price [PLN/pc]
295 × 295	149 × 149	153,07
370 × 370	223 × 223	223,65
445 × 445	297 × 297	288,46
520 × 520	373 × 373	366,07
595 × 595	448 × 448	376,61

Anemostat kasetonowy wirowy • Rectangular swirl diffuser

SW

- elementy konstrukcyjne wykonane z tłoczonej blachy stalowej ocynkowanej
- równomierne rozprowadzenie powietrza zapewnia 36 promieniowo rozmieszczonych łopatek
- wirowy efekt wypływu powietrza zapewnia szybkie wyrównanie temperatur w pomieszczeniu
- odpowiedni do nawiewu/wywiewu ciepłego lub zimnego powietrza
- łatwy montaż - wymiar dostosowany do standardowego sufitu podwieszanego

- structural elements are made of pressed galvanized steel
- even distribution of air is ensured by 36 blades located radially
- swirl effect of air supply ensures quick temperature balance in a room
- good for hot or cold air supply/exhaust
- easy installation - dimension is adapted to standard finished ceiling



Wymiar • Size [mm]	A [mm]	B [mm]	D [mm]	øC [mm]	Cena [PLN/szt.] • Price [PLN/pc]
595 × 595	540	595	595	200	387,83

Anemostat kasetonowy wirowy • Rectangular swirl diffuser

SD-B

- elementy konstrukcyjne wykonane z tłoczonej ocynkowanej blachy stalowej
- nieruchome, skośnie umocowane łopatki zapewniają równomierne rozprowadzenie strumienia powietrza
- wirowy efekt wypływu powietrza zapewnia szybkie wyrównanie temperatur w pomieszczeniu
- odpowiedni do nawiewu zimnego i ciepłego powietrza
- łatwy montaż w suficie podwieszanym 600x600

- structural elements are made of pressed galvanized steel
- immovable, diagonal blades ensure even air stream distribution
- swirl effect of air outflow ensures quick temperature balance in a room
- good for hot or cold air supply/exhaust
- easy installation in finished ceiling 600x600



Wymiar • Size [mm]	□Q [mm]	øL [mm]	Cena [PLN/szt.] • Price [PLN/pc]
300	595	254	416,71
400	595	336	433,04
500	595	440	447,77
600	595	530	483,23
625	620	530	484,58





Anemostat kasetonowy wirowy • Rectangular swirl diffuser

SD-C

- elementy konstrukcyjne wykonane z tłoczonej blachy stalowej ocynkowanej
- kierownice nawiewu wykonane z wysokiej jakości tworzywa sztucznego
- od 8 do 48 promieniowo rozmieszczonych skośnych szczelin zapewnia równomierne rozprowadzenie strumienia
- możliwość uzyskania do 30 wymian powietrza
- możliwość stosowania do nawiewu lub wywiewu powietrza





- structural elements are made of pressed galvanized steel
- directional lamellas are made of high quality plastic
- 8 to 48 diagonal slots located radially ensure even distribution of air
- possibility to achieve up to 30 air exchanges
- it is possible to use air exhaust or supply



SD-C 300 8 szczelin • slots	SD-C 400 16 szczelin • slots	SD-C 500 24 szczeliny • slots	SD-C 600 24 szczeliny • slots	SD-C 600 48 szczelin • slots
□300	□398	□498	□598	□598
				
Cena [PLN/szt.] • Price [PLN/pc]				
271,24	348,40	400,06	439,95	474,73



Anemostat sufitowy nawiewny • Rectangular ceiling diffuser								ASN	
Wielkość • Size	0	1	2	3	4	5	6	7	8
Wymiar • Dimension [mm]	190	245	301	357	412	469	498	598	623
Rodzaj • Type	Cena [PLN/szt.] • Price [PLN/pc]								
ASN	68,00	83,00	98,00	116,00	143,00	177,00	186,00	206,00	216,00
ASN-P	×	117,00	149,00	177,00	218,00	285,00	304,00	388,00	440,00

ASN-0 nawiewny wirowy • supply swirl	ASN-1 nawiewny jednostronny • one side supply	ASN-2 nawiewny dwustronny • two side supply	ASN-3 nawiewny trójstronny • three side supply	ASN-5 nawiewny narożny • corner supply
				
ASN × 1,5	ASN × 1,3	ASN × 1,3	ASN × 1,5	ASN × 1,5

Anemostat sufitowy wywiewny • Exhaust ceiling diffuser	ASW
--	-----



Wielkość • Size	0	1	2	3	4	5	6	7	8
Wymiar • Dimension [mm]	190	245	301	357	412	469	498	598	623
Cena [PLN/szt.] • Price [PLN/pc]	52,00	63,00	73,00	87,00	101,00	111,00	125,00	141,00	147,00

Anemostat sufitowy wywiewny z przepustnicą • Exhaust ceiling diffuser with the damper	ASW-P
--	-------



Wielkość • Size	1	2	3	4	5	6	7	8
Wymiar • Dimension [mm]	301	357	412	469	498	598	623	623
Cena [PLN/szt.] • Price [PLN/pc]	116,00	134,00	184,00	218,00	263,00	307,00	450,00	459,00

Wykonanie: blacha kwasoodporna - cena × 4 • Execution: acid-proof sheet - price × 4



Anemostat sufitowy prostokątny • Rectangular ceiling diffuser (ASN6 ÷ ASN13)

ASN

Wymiar • Size	
L [mm]	H [mm]
498	357
598	357
714	357
824	357
996	357
1196	357
1407	357
598	412
714	412
824	412
996	412
1196	412
1407	412
714	469
824	469
996	469
1196	469
1407	469
824	498
996	498
1196	498
1407	498
996	598
1196	598
1407	598
1096	598
1246	714
714	714
1407	714

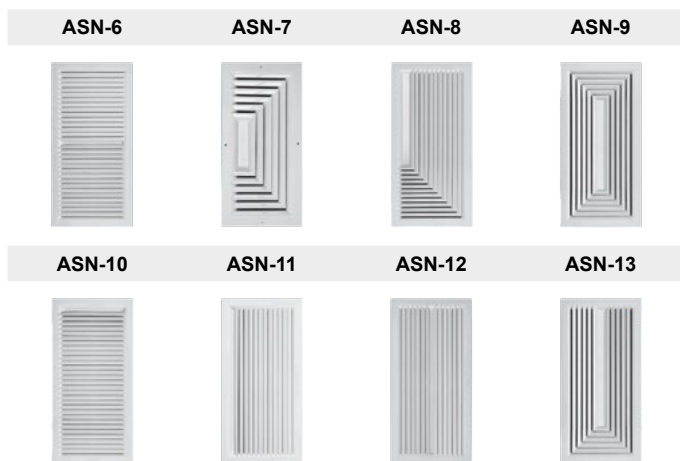

OFERTY CENOWE NA ZAPYTANIE • PRICE FOR ENQUIRY

ASN	sufitowy nawiewny tylko kratka • supply ceiling diffuser the grille only
ASN-P	sufitowy nawiewny z przepustnicą • supply ceiling diffuser with the damper
ASN-PSR	sufitowy nawiewny z przepustnicą i skrzynką rozprężną • supply ceiling diffuser with the damper and plenum box
ASN-PSRI	sufitowy nawiewny z przepustnicą i skrzynką rozprężną izolowaną akustycznie • supply ceiling diffuser with the damper and plenum box with acoustic insulation
ASN-SR	sufitowy nawiewny ze skrzynką rozprężną • supply ceiling diffuser with the plenum box
ASN-SRI	sufitowy nawiewny ze skrzynką rozprężną izolowaną akustycznie • supply ceiling diffuser with the plenum box with acoustic insulation
ASN-SRP	sufitowy nawiewny ze skrzynką rozprężną i przepustnicą na wlocie • supply ceiling diffuser with the plenum box and damper at the inlet
ASN-SRIP	sufitowy nawiewny ze skrzynką rozprężną izolowaną akustycznie i przepustnicą na wlocie • supply ceiling diffuser with the plenum box with acoustic insulation and the damper at the inlet

Dysza dalekiego zasięgu • Jet diffuser

JNS



Wielkość • Size [mm]	D1 [mm]	D2 [mm]	D3 [mm]	E [mm]	F [mm]	L1 [mm]	Cena [PLN/szt.] • Price [PLN/pc]
100	162	98	50	10	-2	78	388,28
125	185	123	64	10	4	89	495,35
160	216	158	82	11	10	106	630,06
200	273	198	108	16	14	127	717,19
250	318	248	136	16	23	159	899,49
315	400	313	174	23	29	189	1 129,37
400	483	398	230	24	47	223	1 434,38
500	596	498	286	27,5	60	290	1 797,96



Skrzynka rozprężna • Plenum box

SR-ASN



Wielkość kratki • Grille size [mm]	Wymiar • Size AxA [mm]	Cena [PLN/szt.] • Price [PLN/pc]			
		Tylko skrzynka • Box only SR-ASN	Skrzynka z przepustnicą • Box with damper SR-P ASN	Skrzynka z izolacją akustyczną • Box with acoustic insulation SR-I ASN ^(*)	Skrzynka z przepustnicą oraz izolacją akustyczną • Box with damper and acoustic insulation SR-I-P ASN ^(*)
190×190	150×150	97,00	117,00	162,00	195,00
245×245	204×204	103,00	120,00	171,00	201,00
301×301	260×260	123,00	158,00	207,00	257,00
357×357	316×316	149,00	169,00	248,00	284,00
412×412	372×372	161,00	189,00	266,00	313,00
469×469	428×428	186,00	204,00	310,00	337,00
498×498	457×457	201,00	224,00	334,00	370,00
598×598	557×557	232,00	253,00	384,00	417,00
623×623	582×582	253,00	281,00	420,00	464,00

Skrzynka rozprężna • Plenum box

SR-HB40

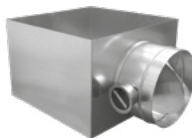

Wielkość anemostatu • Diffuser size [mm]	Wymiar • Size AxA [mm]	Cena [PLN/szt.] • Price [PLN/pc]			
		Tylko skrzynka • Box only SR-HB40	Skrzynka z przepustnicą • Box with damper SR-P HB40	Skrzynka z izolacją akustyczną • Box with acoustic insulation SR-I HB40 ^(*)	Skrzynka z przepustnicą oraz izolacją akustyczną • Box with damper and acoustic insulation SR-I-P HB40 ^(*)
295×295	149×149	88,00	107,00	148,00	177,00
370×370	222×223	99,00	126,00	179,00	193,00
445×445	298×298	118,00	164,00	216,00	256,00
520×520	373×373	142,00	184,00	270,00	284,00
595×595	448×448	161,00	215,00	300,00	354,00

^(*) Izolacja: mata termoizolacyjna samoprzylepna MST • Insulation: thermal insulation adhesive mat MST



Skrzynka rozprężna • Plenum box

SR-SD-B

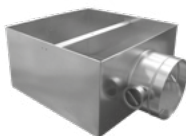

Typ anemostatu • Diffuser type [mm]	Wymiar • Size AxA [mm]	Cena [PLN/szt.] • Price [PLN/pc]			
		Tylko skrzynka • Box only SR-SD-B	Skrzynka z przepustnicą • Box with damper SR-P SD-B	Skrzynka z izolacją akustyczną • Box with acoustic insulation SR-I SD-B ^(*)	Skrzynka z przepustnicą oraz izolacją akustyczną • Box with damper and acoustic insulation SR-I-P SD-B ^(*)
SD-B 300	580x580	220,00	255,00	360,00	425,00
SD-B 400					
SD-B 500					
SD-B 600					
SD-B 625					

Skrzynka rozprężna • Plenum box

SR-SD-C

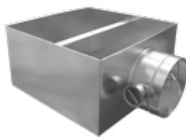

Typ anemostatu • Diffuser type [mm]	Wymiar • Size AxA [mm]	Cena [PLN/szt.] • Price [PLN/pc]			
		Tylko skrzynka • Box only SR-SD-C	Skrzynka z przepustnicą • Box with damper SR-P SD-C	Skrzynka z izolacją akustyczną • Box with acoustic insulation SR-I SD-C ^(*)	Skrzynka z przepustnicą oraz izolacją akustyczną • Box with damper and acoustic insulation SR-I-P SD-C ^(*)
SD-C 300	285x285	109,00	124,00	179,00	212,00
SD-C 400	367x367	153,00	176,00	253,00	299,00
SD-C 500	455x455	189,00	218,00	312,00	369,00
SD-C 600	580x580	219,00	252,00	362,00	428,00

^(*) Izolacja: mata termoizolacyjna samoprzylepna MST • Insulation: thermal insulation adhesive mat MST



Skrzynka rozprężna • Plenum box

SR-SW

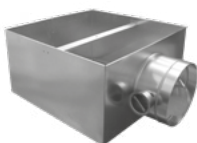

Wymiar anemostatu • Diffuser size [mm]	Wymiar • Size AxA [mm]	Cena [PLN/szt.] • Price [PLN/pc]			
		Tylko skrzynka • Box only SR-SW	Skrzynka z przepustnicą • Box with damper SR-P SW	Skrzynka z izolacją akustyczną • Box with acoustic insulation SR-I SW ^(*)	Skrzynka z przepustnicą oraz izolacją akustyczną • Box with damper and acoustic insulation SR-I-P SW ^(*)
595x595	580x580	229,00	264,00	379,00	448,00

Skrzynka rozprężna • Plenum box

SR-EG-C

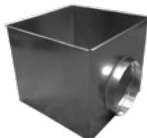

Wymiar kratki • Grille size [mm]	Wymiar • Size AxA [mm]	Cena [PLN/szt.] • Price [PLN/pc]			
		Tylko skrzynka • Box only SR-EG-C	Skrzynka z przepustnicą • Box with damper SR-P EG-C	Skrzynka z izolacją akustyczną • Box with acoustic insulation SR-I EG-C ^(*)	Skrzynka z przepustnicą oraz izolacją akustyczną • Box with damper and acoustic insulation SR-I-P EG-C ^(*)
595x595	565x565	216,00	238,00	359,00	393,00

Przyłącze montażowe okrągłe • Circular diffuser connection

DSP



Wielkość anemostatu DS [mm]	Wymiar przyłącza D [mm]	Wysokość przyłącza H ₁ [mm]	Wymiar podstawy A [mm]	Cena [PLN/szt.]
160	159	140	257	49,06
200	199	140	307	55,52
250	249	140	357	66,85
300	314	140	407	71,83
350	349	140	457	75,12

^(*) Izolacja: mata termoizolacyjna samoprzylepna MST • Insulation: thermal insulation adhesive mat MST

Kratka ścienna aluminiowa • Aluminium wall grille

KSH-P-AL



L [mm]	160	200	250	315	400	500
H [mm]	Cena [PLN/szt.] • Price [PLN/pc]					
160	113,75	134,27	146,84	165,19	195,67	237,59
200	x	142,65	160,09	180,83	214,37	259,57
250	x	x	177,09	200,54	238,72	291,18
315	x	x	x	225,70	269,65	329,93
400	x	x	x	x	310,55	381,14
500	x	x	x	x	x	440,40

Kratka wyciągowa aluminiowa • Exhaust grille

EG-C



H [mm]	H1 [mm]	Cena [PLN/szt.]
595	595	235,90

Kratka na kanały okrągłe ocynkowana • Grille for round ducts

SGD



H [mm]	75	125	175	225
L [mm]	Cena [PLN/szt.] • Price [PLN/pc]			
425	74,55	98,80	x	137,32
525	112,28	119,20	130,64	x
625	x	x	x	193,29

Przepustnica na kratkę SGD • Damper for grille SGD

PSGD



H [mm]	75	125	225
L [mm]	Cena [PLN/szt.] • Price [PLN/pc]		
425	84,87	97,78	125,08
525	99,47	116,14	x
625	x	x	170,85



Kratka wentylacyjna ścienna z kierownicami poziomymi

• Grille with horizontal blades

KSH



L [mm]	125	225	325	425	525	625	825	1025	1225
H [mm]	Cena [PLN/szt.] • Price [PLN/pc]								
75	45,00	52,00	58,00	63,00	69,00	87,00	106,00	134,00	164,00
125	55,00	59,00	65,00	70,00	80,00	100,00	123,00	153,00	185,00
225	×	70,00	80,00	86,00	96,00	125,00	149,00	186,00	226,00
325	×	×	92,00	100,00	113,00	147,00	177,00	218,00	267,00
425	×	×	×	123,00	134,00	177,00	210,00	267,00	315,00
525	×	×	×	×	162,00	210,00	256,00	315,00	377,00
625	×	×	×	×	×	268,00	304,00	377,00	454,00

Kratka wentylacyjna ścienna z kierownicami poziomymi i przepustnicą

• Grille with horizontal blades and damper

KSH-P



L [mm]	125	225	325	425	525	625	825	1025	1225
H [mm]	Cena [PLN/szt.] • Price [PLN/pc]								
75	77,00	91,00	109,00	128,00	147,00	194,00	228,00	292,00	371,00
125	89,00	105,00	121,00	136,00	164,00	217,00	255,00	325,00	398,00
225	×	122,00	145,00	168,00	198,00	267,00	311,00	398,00	488,00
325	×	×	171,00	201,00	233,00	321,00	378,00	482,00	565,00
425	×	×	×	243,00	290,00	396,00	463,00	565,00	672,00
525	×	×	×	×	351,00	484,00	554,00	672,00	787,00
625	×	×	×	×	×	591,00	661,00	787,00	950,00

Wykonanie: blacha kwasoodporna - cena × 4 • Execution: acid resistant sheet - price × 4

Malowanie na kolor niestandardowy +20% • Painting in not standard color +20%

Wymiary otworu montażowego L/H • Size of the assembly opening L/H

Inne wymiary na zapytanie • Other dimensions for enquiry



Kratka wentylacyjna ścienna z kierownicami pionowymi

• Grille with vertical blades

KSV



L [mm]	125	225	325	425	525	625	825	1025	1225
H [mm]	Cena [PLN/szt.] • Price [PLN/pc]								
75	52,00	58,00	63,00	69,00	75,00	99,00	120,00	149,00	183,00
125	55,00	65,00	70,00	80,00	86,00	118,00	136,00	169,00	204,00
225	×	70,00	86,00	96,00	103,00	141,00	164,00	207,00	245,00
325	×	×	92,00	113,00	124,00	162,00	193,00	241,00	293,00
425	×	×	×	123,00	149,00	193,00	232,00	293,00	348,00
525	×	×	×	×	162,00	232,00	278,00	348,00	418,00
625	×	×	×	×	×	268,00	337,00	419,00	501,00

Kratka wentylacyjna ścienna z kierownicami pionowymi i przepustnicą

• Grille with vertical blades and damper

KSV-P



L [mm]	125	225	325	425	525	625	825	1025	1225
H [mm]	Cena [PLN/szt.] • Price [PLN/pc]								
75	85,00	97,00	113,00	133,00	154,00	206,00	242,00	306,00	389,00
125	89,00	110,00	125,00	146,00	169,00	233,00	268,00	341,00	416,00
225	×	122,00	152,00	178,00	206,00	282,00	326,00	419,00	509,00
325	×	×	171,00	215,00	244,00	336,00	395,00	505,00	591,00
425	×	×	×	243,00	305,00	411,00	485,00	591,00	704,00
525	×	×	×	×	351,00	506,00	576,00	704,00	826,00
625	×	×	×	×	×	591,00	693,00	827,00	997,00

Wykonanie: blacha kwasoodporna - cena × 4 • Execution: acid resistant sheet - price × 4

Malowanie na kolor niestandardowy +20% • Painting in not standard color +20%

Wymiary otworu montażowego L/H • Size of the assembly opening L/H

Inne wymiary na zapytanie • Other dimensions for enquiry

Kratka wentylacyjna ścienna z dwoma rzędami kierownic
• Grille with double-row blades

KSH-V / KSV-H



L [mm]	125	225	325	425	525	625	825	1025	1225
H [mm]	Cena [PLN/szt.] • Price [PLN/pc]								
75	65,00	69,00	77,00	88,00	99,00	130,00	161,00	196,00	244,00
125	72,00	80,00	86,00	99,00	123,00	152,00	186,00	244,00	293,00
225	x	96,00	106,00	123,00	146,00	177,00	233,00	293,00	358,00
325	x	x	124,00	146,00	171,00	226,00	283,00	358,00	425,00
425	x	x	x	171,00	210,00	271,00	340,00	425,00	510,00
525	x	x	x	x	250,00	325,00	408,00	510,00	607,00
625	x	x	x	x	x	388,00	487,00	607,00	734,00

Kratka wentylacyjna ścienna z dwoma rzędami kierownic i przepustnicą
• Grille with double-row blades and damper

KSH-VP / KSV-HP



L [mm]	125	225	325	425	525	625	825	1025	1225
H [mm]	Cena [PLN/szt.] • Price [PLN/pc]								
75	98,00	108,00	129,00	153,00	178,00	237,00	283,00	353,00	451,00
125	107,00	124,00	142,00	166,00	207,00	267,00	318,00	416,00	506,00
225	x	147,00	171,00	206,00	250,00	318,00	396,00	505,00	620,00
325	x	x	204,00	246,00	290,00	398,00	485,00	620,00	723,00
425	x	x	x	290,00	366,00	491,00	593,00	723,00	868,00
525	x	x	x	x	438,00	597,00	705,00	868,00	1 016,00
625	x	x	x	x	x	711,00	845,00	1 016,00	1 230,00

Wykonanie: blacha kwasoodporna - cena × 4 • Execution: acid resistant sheet - price × 4

Malowanie na kolor niestandardowy +20% • Painting in not standard color +20%

Wymiary otworu montażowego L/H • Size of the assembly opening L/H

Inne wymiary na zapytanie • Other dimensions for enquiry

Kratka wentylacyjna ścienna z kierownicami poziomymi i przepustnicą jednoelementową
• Grille with double-row blades
KSH-N

L [mm]	125	225	325	425	525	625	825	1025	1225
H [mm]	Cena [PLN/szt.] • Price [PLN/pc]								
75	65,00	75,00	87,00	98,00	111,00	149,00	176,00	230,00	279,00
125	77,00	85,00	97,00	110,00	124,00	165,00	202,00	255,00	316,00
225	×	100,00	117,00	130,00	158,00	205,00	246,00	309,00	373,00
325	×	×	134,00	157,00	182,00	243,00	294,00	366,00	444,00
425	×	×	×	191,00	227,00	294,00	354,00	444,00	528,00
525	×	×	×	×	274,00	354,00	427,00	528,00	617,00
625	×	×	×	×	×	438,00	508,00	617,00	741,00

Kratka wentylacyjna ścienna z dwoma rzędami kierownic i z przepustnicą jednoelementową
• Grille with double-row blades and deflector flap damper
**KSH-VN
/ KSV-HN**

L [mm]	125	225	325	425	525	625	825	1025	1225
H [mm]	Cena [PLN/szt.] • Price [PLN/pc]								
75	86,00	92,00	107,00	123,00	142,00	191,00	231,00	292,00	361,00
125	95,00	106,00	118,00	140,00	168,00	216,00	265,00	348,00	424,00
225	×	125,00	142,00	167,00	209,00	255,00	331,00	415,00	505,00
325	×	×	167,00	204,00	239,00	321,00	400,00	506,00	602,00
425	×	×	×	239,00	303,00	388,00	484,00	602,00	724,00
525	×	×	×	×	361,00	469,00	579,00	724,00	847,00
625	×	×	×	×	×	558,00	692,00	847,00	1 021,00

Wykonanie: blacha kwasoodporna - cena × 4 • Execution: acid resistant sheet - price × 4

Malowanie na kolor niestandardowy +20% • Painting in not standard color +20%

Wymiary otworu montażowego L/H • Size of the assembly opening L/H

Inne wymiary na zapytanie • Other dimensions for enquiry

**Kratka wentylacyjna ścienna z kierownicami pionowymi
i przepustnicą jednoelementową**
• Grille with vertical blades and deflector flap damper
KSV-N

L [mm]	125	225	325	425	525	625	825	1025	1225
H [mm]	Cena [PLN/szt.] • Price [PLN/pc]								
75	73,00	81,00	92,00	105,00	118,00	161,00	190,00	244,00	299,00
125	77,00	91,00	101,00	120,00	131,00	182,00	216,00	273,00	334,00
225	x	100,00	122,00	140,00	166,00	219,00	262,00	329,00	394,00
325	x	x	134,00	171,00	193,00	257,00	310,00	389,00	470,00
425	x	x	x	191,00	241,00	310,00	376,00	470,00	560,00
525	x	x	x	x	274,00	376,00	449,00	560,00	657,00
625	x	x	x	x	x	438,00	541,00	658,00	789,00

Kratka ścienna • Wall grille
KWP

L [mm]	125	225	325	425	525	625	825	1025	1225
H [mm]	Cena [PLN/szt.] • Price [PLN/pc]								
75	53,00	59,00	67,00	73,00	83,00	100,00	129,00	162,00	193,00
125	63,00	69,00	80,00	84,00	91,00	118,00	144,00	182,00	218,00
225	81,00	84,00	91,00	100,00	116,00	142,00	177,00	221,00	262,00
325	87,00	105,00	109,00	120,00	133,00	169,00	210,00	259,00	314,00
425	97,00	117,00	138,00	143,00	160,00	202,00	245,00	314,00	372,00
525	105,00	134,00	153,00	184,00	190,00	240,00	299,00	372,00	450,00
625	134,00	171,00	193,00	232,00	275,00	290,00	359,00	450,00	535,00
825	162,00	195,00	232,00	275,00	334,00	399,00	492,00	592,00	710,00
1025	204,00	245,00	288,00	349,00	414,00	504,00	619,00	747,00	894,00
1225	245,00	290,00	349,00	414,00	504,00	597,00	736,00	884,00	1 063,00



Maskownica • Frame

M



L [mm]	125	225	325	425	525	625	825	1025	1225
H [mm]	Cena [PLN/szt.] • Price [PLN/pc]								
75	23,00	25,00	29,00	31,00	33,00	39,00	52,00	65,00	77,00
125	28,00	29,00	32,00	33,00	36,00	47,00	58,00	73,00	86,00
225	x	33,00	36,00	39,00	45,00	58,00	72,00	87,00	103,00
325	x	x	44,00	48,00	53,00	69,00	84,00	103,00	125,00
425	x	x	x	58,00	65,00	83,00	99,00	125,00	146,00
525	x	x	x	x	75,00	97,00	120,00	146,00	180,00
625	x	x	x	x	x	118,00	143,00	180,00	216,00
825	x	x	x	x	x	x	196,00	239,00	285,00
1025	x	x	x	x	x	x	x	298,00	361,00
1225	x	x	x	x	x	x	x	x	425,00

Kratka z siatką • Grille with mesh

KWS



L [mm]	125	225	325	425	525	625	825	1025	1225
H [mm]	Cena [PLN/szt.] • Price [PLN/pc]								
75	39,00	44,00	47,00	58,00	65,00	75,00	103,00	161,00	202,00
125	44,00	47,00	62,00	69,00	81,00	88,00	125,00	176,00	227,00
225	x	62,00	69,00	81,00	88,00	100,00	144,00	202,00	244,00
325	x	x	81,00	88,00	100,00	123,00	176,00	227,00	276,00
425	x	x	x	100,00	123,00	141,00	202,00	244,00	307,00
525	x	x	x	x	141,00	169,00	227,00	277,00	337,00
625	x	x	x	x	x	197,00	244,00	307,00	366,00

Malowanie na kolor standardowy + 10%, niestandardowy +25% • Painting in standard color + 10%, not standard + 25%

Wymiary otworu montażowego L/H • Size of the assembly opening L/H

Inne wymiary na zapytanie • Other dimensions for enquiry

ANEMOSTATY, NAWIEWNIKI, KRATKI, ZAWORY

Kratki podłogowe, Kratki wentylacyjne 45/90° • Floor grilles, grilles 45/90°

 RDJ Klima



Kratka podłogowa • Floor grille

KNP



L [mm]	125	225	325	425	525	625	825	1025	1225
H [mm]	Cena [PLN/szt.] • Price [PLN/pc]								
125	240,00	264,00	289,00	318,00	370,00	440,00	542,00	681,00	817,00
225	×	317,00	347,00	384,00	422,00	529,00	652,00	802,00	981,00
325	×	×	418,00	501,00	551,00	692,00	854,00	1 069,00	1 287,00

Kratka wentylacyjna z nieruchomymi kierownicami o nachyleniu 45° lub 90° • Grille with fixed blades on a tilt of 45° or 90°

KSH-45
KSH-90



L [mm]	125	225	325	425	525	625	825	1025	1225
H [mm]	Cena [PLN/szt.] • Price [PLN/pc]								
75	46,00	52,00	58,00	63,00	72,00	88,00	112,00	142,00	174,00
125	55,00	59,00	65,00	72,00	81,00	103,00	129,00	160,00	195,00
225	65,00	72,00	81,00	87,00	98,00	129,00	156,00	196,00	233,00
325	73,00	87,00	96,00	101,00	118,00	149,00	184,00	228,00	278,00
425	81,00	98,00	118,00	125,00	136,00	180,00	219,00	278,00	329,00
525	87,00	105,00	128,00	152,00	166,00	213,00	267,00	329,00	398,00
625	120,00	144,00	166,00	196,00	239,00	274,00	319,00	398,00	479,00
825	141,00	167,00	196,00	234,00	285,00	342,00	440,00	527,00	628,00
1025	174,00	212,00	249,00	300,00	358,00	427,00	521,00	628,00	755,00
1225	210,00	250,00	300,00	358,00	426,00	510,00	628,00	755,00	905,00

Wykonanie: blacha kwasoodporna - cena × 4 • Execution: acid resistant sheet - price × 4

Wymiary otworu montażowego L/H • Size of the assembly opening L/H

Inne wymiary na zapytanie • Other dimensions for enquiry



Kratka wentylacyjna osłonowa maskująca • Masking grille

KST

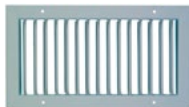

L [mm]	75	125	225	325	425	525	625	825	1025	1225
H [mm]	Cena [PLN/szt.] • Price [PLN/pc]									
75	×	52,00	58,00	65,00	72,00	83,00	99,00	125,00	153,00	186,00
125	58,00	61,00	68,00	75,00	84,00	87,00	109,00	141,00	177,00	210,00
225	70,00	77,00	84,00	87,00	99,00	106,00	141,00	171,00	210,00	252,00
325	76,00	84,00	99,00	105,00	119,00	130,00	164,00	198,00	245,00	300,00
425	86,00	87,00	110,00	125,00	141,00	156,00	193,00	239,00	300,00	359,00
525	96,00	99,00	123,00	143,00	171,00	185,00	230,00	287,00	359,00	432,00
625	112,00	124,00	152,00	178,00	215,00	256,00	276,00	342,00	432,00	565,00
825	130,00	146,00	180,00	215,00	256,00	310,00	366,00	457,00	565,00	679,00
1025	162,00	185,00	230,00	267,00	321,00	383,00	460,00	565,00	679,00	813,00
1225	191,00	221,00	278,00	321,00	383,00	460,00	548,00	679,00	813,00	978,00

Kratka wentylacyjna osłonowa maskująca z przepustnicą jednopłaszczyznową
• Masking grille with single-leaf damper

KST-P



L [mm]	75	125	225	325	425	525	625	825	1025	1225
H [mm]	Cena [PLN/szt.] • Price [PLN/pc]									
75	×	85,00	97,00	117,00	135,00	161,00	206,00	249,00	310,00	394,00
125	91,00	96,00	112,00	131,00	150,00	171,00	226,00	273,00	349,00	424,00
225	106,00	124,00	135,00	153,00	182,00	208,00	282,00	333,00	422,00	516,00
325	123,00	147,00	171,00	183,00	219,00	250,00	337,00	400,00	509,00	597,00
425	150,00	160,00	202,00	234,00	261,00	312,00	411,00	492,00	597,00	715,00
525	168,00	193,00	237,00	276,00	343,00	374,00	504,00	584,00	715,00	842,00
625	206,00	252,00	306,00	366,00	458,00	556,00	597,00	700,00	842,00	1 062,00
825	256,00	303,00	374,00	458,00	556,00	663,00	791,00	953,00	1 134,00	1 335,00
1025	318,00	389,00	482,00	581,00	674,00	807,00	946,00	1 192,00	1 432,00	1 680,00
1225	396,00	474,00	592,00	674,00	807,00	946,00	1 137,00	1 368,00	1 767,00	2 013,00

Wykonanie: blacha kwasoodporna - cena × 4 • Execution: acid resistant sheet - price × 4

Wymiary otworu montażowego L/H • Size of the assembly opening L/H

Inne wymiary na zapytanie • Other dimensions for enquiry



Kratka wentylacyjna na kanał zwijany z kierownicami poziomymi

• Grille for circular ducts with horizontal blades

KSH-1

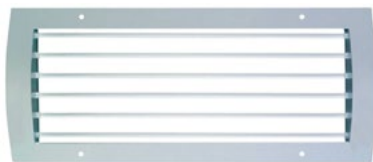

L [mm]	125	225	325	425	525	625	825	1025	1225
H [mm]	Cena [PLN/szt.] • Price [PLN/pc]								
75	69,00	75,00	81,00	91,00	100,00	133,00	160,00	207,00	246,00
125	86,00	84,00	92,00	101,00	111,00	152,00	183,00	232,00	276,00
225	x	101,00	111,00	129,00	138,00	185,00	226,00	285,00	334,00
325	x	x	134,00	147,00	164,00	215,00	257,00	331,00	397,00
425	x	x	x	176,00	196,00	257,00	311,00	397,00	476,00
525	x	x	x	x	232,00	311,00	372,00	476,00	571,00
625	x	x	x	x	x	392,00	444,00	571,00	684,00

Kratka wentylacyjna na kanał zwijany z kierownicami poziomymi i przepustnicą jednoelementową

• Grille for circular ducts with horizontal blades and single-leaf damper

KSH-P-1

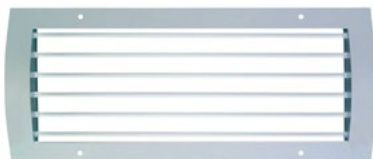

L [mm]	125	225	325	425	525	625	825	1025	1225
H [mm]	Cena [PLN/szt.] • Price [PLN/pc]								
75	101,00	113,00	132,00	155,00	179,00	240,00	282,00	364,00	454,00
125	121,00	129,00	147,00	168,00	195,00	267,00	315,00	404,00	488,00
225	x	154,00	177,00	210,00	241,00	327,00	387,00	496,00	597,00
325	x	x	213,00	249,00	283,00	387,00	460,00	595,00	694,00
425	x	x	x	295,00	352,00	476,00	564,00	694,00	834,00
525	x	x	x	x	421,00	584,00	669,00	834,00	980,00
625	x	x	x	x	x	714,00	801,00	980,00	1 180,00

Wykonanie: blacha kwasoodporna - cena x 4 • Execution: acid resistant sheet - price x 4

Malowanie na kolor niestandardowy +20% • Painting in not standard color +20%

Wymiary otworu montażowego L/H • Size of the assembly opening L/H

Inne wymiary na zapytanie • Other dimensions for enquiry



Kratka wentylacyjna na kanał zwijany z kierownicami pionowymi

• Grille for circular ducts with vertical blades

KSV-1



L [mm]	125	225	325	425	525	625	825	1025	1225
H [mm]	Cena [PLN/szt.] • Price [PLN/pc]								
75	75,00	83,00	91,00	100,00	110,00	146,00	182,00	228,00	274,00
125	80,00	92,00	101,00	111,00	129,00	164,00	200,00	255,00	301,00
225	×	101,00	129,00	138,00	149,00	201,00	240,00	306,00	362,00
325	×	×	134,00	156,00	180,00	239,00	285,00	363,00	442,00
425	×	×	×	176,00	216,00	285,00	339,00	442,00	520,00
525	×	×	×	×	232,00	339,00	414,00	520,00	630,00
625	×	×	×	×	×	392,00	486,00	630,00	752,00

Kratka wentylacyjna na kanał zwijany z kierownicami pionowymi i przepustnicą jednoelementową

• Grille for circular ducts with vertical blades and single-leaf damper

KSV-P-1



L [mm]	125	225	325	425	525	625	825	1025	1225
H [mm]	Cena [PLN/szt.] • Price [PLN/pc]								
75	108,00	121,00	142,00	165,00	189,00	253,00	304,00	385	481,00
125	116,00	136,00	157,00	178,00	212,00	279,00	331,00	427	515,00
225	×	154,00	194,00	220,00	252,00	342,00	402,00	518	626,00
325	×	×	213,00	256,00	300,00	411,00	486,00	627	739,00
425	×	×	×	295,00	372,00	504,00	592,00	739	878,00
525	×	×	×	×	421,00	613,00	712,00	878	1 040,00
625	×	×	×	×	×	714,00	844,00	1 040	1 249,00

Wykonanie: blacha kwasoodporna - cena × 4 • Execution: acid resistant sheet - price × 4

Malowanie na kolor niestandardowy +20% • Painting in not standard color +20%

Wymiary otworu montażowego L/H • Size of the assembly opening L/H

Inne wymiary na zapytanie • Other dimensions for enquiry



Centrala nawiewna • Air supply unit

VEGA



Program dobory:
select.salda.it

- 3 modele z 3 różnymi nagrzewnicami elektrycznymi i model z nagrzewnicą wodną
- 6 możliwych pozycji montażu
- najniższa wysokość w swojej klasie
- nowoczesny i automatyczny system kontroli, integracja z systemami zarządzania budynkiem (RS-485)
- 3 models with 3 different electrical heaters and model with water heater
- 6 mounting positions
- lowest height in the class
- modern automatic control. Integration with building management system

Typ • Type	Wydajn./spręż ¹⁾ • Air flow/compression range ¹⁾ [m ³ /h] / [Pa]	Wymiary ²⁾ • Unit size ²⁾ [mm]	Nagrze- wnica • Heater capacity [kW]	Przyłącze • Ducts connection [mm]	Zasilanie • Supply voltage [V/Hz]		Cena [EUR/szt.] • Price [EUR/pc]
					Nagrzew- nica • Heater	Wentyl- lator • Fan	
VEGA 350	350/100	578×250×1060	1,2 - 5,0	Ø 160	230/50 400/50	230/50	730,00
VEGA 700	800/100	578×300×1260	2,4 - 9,0	Ø 200	230/50 400/50	230/50	850,00
VEGA 1100 E	1180/100	807×340×1400	6,0 - 15,0	500×250	400/50	230/50	1 170,00
VEGA 1100 W	1150/100	807×340×1400	16,1	500×250	WODNA, ZABUDOWANA	230/50	1 630,00

Nagrzewnice dla VEGA 350 • Heaters for VEGA 350	
EH 1.2 1f	120,00 EUR
EH 2.4 1f	140,00 EUR
EH 5.0 2f	300,00 EUR

Nagrzewnice dla VEGA 700 • Heaters for VEGA 700	
EH 2.4 1f	140,00 EUR
EH 5.0 2f	250,00 EUR
EH 9.0 3f	330,00 EUR

Nagrzewnice dla VEGA 1100 E • Heaters for VEGA 1100 E	
EH 6.0 2f	260,00 EUR
EH 9.0 3f	350,00 EUR
EH 15.0 3f	510,00 EUR

Sterowniki • Controllers		
FLEX	EUR/szt. • EUR/pc	260,00

¹⁾ wartości mierzone w punkcie pracy • value at the working point

²⁾ szerokość × wysokość × długość • width × height × length

Ceny przeliczane na PLN w dniu sprzedaży wg kursów średnich NBP.



Centrala nawiewna • Air supply unit

VEKA INT EKO



Program doborowy:
select.salda.it

- zamontowany czujnik ciśnienia w przypadku zanieczyszczenia filtra
- niewielka waga - doskonale do montażu podwieszanego
- wentylatory EC ograniczające zużycie energii i koszty użytkowania
- opcjonalna klasa filtrów: G3, F5 lub F7
- cicha i niezawodna praca
- zabudowana przepustnica z silnikiem
- installed pressure switch for filter pollution
- low height - perfect for under ceilings installation
- EC fan for saving energy and money
- optional filters class: G4, F5 or F7
- quiet and long-life unit



Typ • Type	Wydajność/spręż ^{*)} • Air flow/ compression range ^{*)} [m ³ /h] / [Pa]	Wymiary ^{**)} • Unit size ^{**)} [mm]	Nagrze- wnica • Heater capacity [kW]	Przyłącze • Ducts connection [mm]	Zasilanie • Supply voltage [V/Hz]		Cena [EUR/szt.] • Price [EUR/pc]
					Nagrzew- nica • Heater	Wentylator • Fan	
Nagrzewnice elektryczne • Electrical heaters							
VEKA INT 400-1,2 L1 EKO	580/100	450×325×1190	1,2	Ø 200	230/50	230/50	1 480,00
VEKA INT 400-2,0 L1 EKO	580/100	450×325×1190	2,0	Ø 200	230/50	230/50	1 530,00
VEKA INT 400-5,0 L1 EKO	580/100	450×325×1190	5,0	Ø 200	400/50	230/50	1 570,00
VEKA INT 700-2,4 L1 EKO	900/100	500×350×1280	2,4	Ø 250	230/50	230/50	1 660,00
VEKA INT 700-5,0 L1 EKO	900/100	500×350×1280	5,0	Ø 250	400/50	230/50	1 710,00
VEKA INT 700-9,0 L1 EKO	900/100	500×350×1280	9,0	Ø 250	400/50	230/50	1 820,00
VEKA INT 1000-2,4 L1 EKO	1100/100	635×350×1350	2,4	400×200	230/50	230/50	1 870,00
VEKA INT 1000-5,0 L1 EKO	1100/100	635×350×1350	5,0	400×200	400/50	230/50	1 920,00
VEKA INT 1000-9,0 L1 EKO	1100/100	635×350×1350	9,0	400×200	400/50	230/50	2 030,00
VEKA INT 1000-12,0 L1 EKO	1100/100	635×350×1350	12,0	400×200	400/50	230/50	2 100,00
VEKA INT 2000-6,0 L1 EKO	2550/100	750×460×1650	6,0	500×250	400/50	230/50	2 600,00
VEKA INT 2000-15,0 L1 EKO	2550/100	750×460×1650	15,0	500×250	400/50	230/50	2 780,00
VEKA INT 2000-21,0 L1 EKO	2550/100	750×460×1650	21,0	500×250	400/50	230/50	2 960,00

^{*)} wartości mierzone w punkcie pracy • value at the working point

^{**)} szerokość × wysokość × długość • width × height × length

Ceny przeliczane na PLN w dniu sprzedaży wg kursów średnich NBP.



Typ • Type	Wydajn./spręż ¹⁾ • Air flow/ compression range ²⁾ [m ³ /h] / [Pa]	Wymiary ³⁾ • Unit size ³⁾ [mm]	Nagrze- -wnica • Heater capacity [kW]	Przyłącze • Ducts connection [mm]	Zasilanie • Supply voltage [V/Hz]		Cena [EUR/szt.] • Price [EUR/pc]
					Nagrzew- -nica • Heater	Wentyl- -lator • Fan	
Nagrzewnice elektryczne • Electrical heaters							
VEKA INT 3000-15,0 L1 EKO	3500/250	950×550×1500	15,0	700×400	400/50	230/50	4 260,00
VEKA INT 3000-21,0 L1 EKO	3500/250	950×550×1500	21,0	700×400	400/50	230/50	4 440,00
VEKA INT 3000-30,0 L1 EKO	3500/250	950×550×1500	30,0	700×400	400/50	230/50	4 550,00
VEKA INT 3000-39,0 L1 EKO	3500/250	950×550×1500	39,0	700×400	400/50	230/50	4 830,00
VEKA INT 4000-21,0 L1 EKO	4700/200	950×550×1800	21,0	700×400	400/50	230/50	4 800,00
VEKA INT 4000-27,0 L1 EKO	4700/200	950×550×1800	27,0	700×400	400/50	230/50	4 940,00
VEKA INT 4000-39,0 L1 EKO	4700/200	950×550×1800	39,0	700×400	400/50	230/50	5 240,00
VEKA INT 4000-54,0 L1 EKO	4700/200	950×550×1800	54,0	700×400	400/50	230/50	5 330,00
Nagrzewnice wodne • Water heaters							
VEKA INT 1000 W L1 EKO	1000/100	635×350×1350	14,4	400×200	WODNA • WATER	230/50	2 030,00
VEKA INT 2000 W L1 EKO	2000/300	750×460×1650	27,0	500×250	WODNA • WATER	230/50	3 370,00
VEKA INT 3000 W L1 EKO	3500/250	950×550×1500	40,6	700×400	WODNA • WATER	230/50	4 580,00
VEKA INT 4000 W L1 EKO	4500/250	950×550×1800	54,0	700×400	WODNA • WATER	230/50	4 780,00

Zestaw do centrali z nagrzewnicą wodną (zawór + siłownik + śrubunek)

ZS	EUR/szt. • EUR/pc	320,00
-----------	-------------------	--------

Sterownik • Controller

FLEX	EUR/szt. • EUR/pc	260,00
-------------	-------------------	--------

¹⁾ wartości mierzone w punkcie pracy • value at the working point²⁾ szerokość × wysokość × długość • width × height × length

Ceny przeliczane na PLN w dniu sprzedaży wg kursów średnich NBP.



Centrala wentylacyjna z odzyskiem ciepła

• Air handling unit with heat recovery

SMARTY

ODZYSK DO 92%.

Silniki EC.

Automatyka sterowania.

Regulowana wydajność powietrza
i temperatura powietrza nawiewanego.

RECUPERATION UP 92%.

EC motors.

Integrated control.

Controlled air flow

and supply air temperature control.

Program doborowy:
select.salda.it

Wymiennik przeciwprądowy.

Grubość ścianek: 30 mm.

Klasa filtra nawiew/wywiew: G4/G4.

Counter-flow heat exchanger.

Wall thickness: 30 mm.

Supply/Exhaust filter class: G4/G4.

Wymiennik obrotowy.

Grubość ścianek: 20 mm.

Klasa filtra nawiew/wywiew: M5/M5.

Rotor heat exchanger.

Wall thickness: 20 mm.

Supply/Exhaust filter class: M5/M5.

V - układ pionowy

P - podsufitowe

E - nagrzewnica elektr.

V - vertical set

P - under-ceiling

E - electric heater

Model	Wydajność/spręż ^{*)} • Efficiency/Compression range [m ³ /h] / [Pa]	Moc nagrzewnicy • Heater capacity [kW]	Przyłącze • Connection [mm]	Cena katalogowa • Price [EUR/szt.] • [EUR/pc]
Centrala wentylacyjne z wymiennikiem przeciwprądowym				
Smarty 2X P 1.1	230 / 100	EKA NIS ^{**)}	125	1 810,00
Smarty 2X V 1.1 ^{***)}	180 / 100	0,6	125	1 940,00
Smarty 3X P 1.1	400 / 100	EKA NIS ^{**)}	160	2 070,00
Smarty 3X V 1.1 ^{***)}	420 / 100	1,2	160	2 120,00
Smarty 4X P F2 1.1	590 / 100	EKA NIS ^{**)}	160	2 580,00
Smarty 4X V F2 1.1 ^{***)}	590 / 100	1,2	160	2 650,00
Centrala wentylacyjna z wymiennikiem obrotowym				
Smarty 2R VE PLUS	210 / 100	0,6	125	2 130,00

Sterowniki • Controllers		
WIFASET	EUR/szt. • EUR/pc	260,00
SA-CONTROL		320,00

*) wartości mierzone w punkcie pracy • value at the working point

**) nagrzewnica elektryczna kanałowa (dopłata) • duct electrical heater (additional payment)

***) przy montażu na podłodze wymagane nóżki (dopłata) • when mounting on the floor, assembling supports is necessary (additional payment)

Ceny przeliczone na PLN w dniu sprzedaży wg kursów średnich NBP.



Centrala wentylacyjna z odzyskiem ciepła

• Air handling unit with heat recovery

RIS VE EKO 3.0

Program dorobowy:
select.salda.it

V - układ pionowy • vertical set

E - nagrzewnica elektryczna • electric heater

Wymiennik przeciwprądowy: **ODZYSK DO 94%**.

Grubość ścianek: 30-50 mm.

Klasa filtra nawiewnego: F7.

Klasa filtra wywiewnego: F5.

Silniki EC.

Automatyka sterowania.

Regulowana wydajność powietrza i temperatura powietrza nawiewanego.

Counter-flow heat exchanger: RECOVERY UP 94%.

Wall thickness: 30-50 mm.

Supply filter class: F7.

Exhaust filter class: F5.

EC motors.

Integrated control.

Controlled air flow and supply air temperature control.

Model	Wydajność/spręż ^{*)} • Efficiency/Compression range [m ³ /h] / [Pa]	Moc nagrzewnicy • Heater capacity [kW]	Przyłącze • Connection [mm]	Cena katalogowa • Price [EUR/szt.] • [EUR/pc]
RIS 700 VE EKO 3.0	800/100	1,2	Ø 250	3 450,00
RIS 1200 VE EKO 3.0	1200/200	2,0	Ø 315	5 220,00
RIS 1900 VE EKO 3.0	2000/200	3,0	Ø 400	7 960,00
RIS 2200 VE EKO 3.0	2200/200	3,0	Ø 400	8 370,00

Sterowniki • Controllers		
FLEX	EUR/szt. • EUR/pc	260,00
WIFSET		260,00
SA-CONTROL		320,00

*) wartości mierzone w punkcie pracy • value at the working point

Ceny przeliczone na PLN w dniu sprzedaży wg kursów średnich NBP.



Centrala wentylacyjna z odzyskiem ciepła

• Air handling unit with heat recovery

RIS VW EKO 3.0



V - układ pionowy • vertical set

W - nagrzewnica wodna • water heater

Wymiennik przeciwprądowy: **ODZYSK DO 94%**.

Grubość ścianek: 30-50 mm.

Klasa filtra nawiewnego: F7.

Klasa filtra wywiewnego: F5.

Silniki EC.

Automatyka sterowania.

Regulowana wydajność powietrza i temperatura powietrza nawiewanego.

Counter-flow heat exchanger: RECOVERY UP 94%.

Wall thickness: 30-50 mm.

Supply filter class: F7.

Exhaust filter class: F5.

EC motors.

Integrated control.

Controlled air flow and supply air temperature control.

Model	Wydajność/spręż ^{*)} • Efficiency/Compression range [m ³ /h] / [Pa]	Moc nagrzewnicy • Heater capacity [kW]	Przyłącze • Connection [mm]	Cena katalogowa • Price [EUR/szt.] • [EUR/pc]
RIS 700 VW EKO 3.0	800/100	AVS 250 ^{**)}	Ø 250	3 340,00
RIS 1200 VW EKO 3.0	1200/200	AVS 315 ^{**)}	Ø 315	5 280,00
RIS 1900 VW EKO 3.0	2000/200	AVS 400 ^{**)}	Ø 400	7 850,00
RIS 2200 VW EKO 3.0	2200/200	AVS 400 ^{**)}	Ø 400	8 300,00

Zestaw do centrali z nagrzewnicą wodną (zawór + siłownik + śrubunek)		
ZS	EUR/szt. • EUR/pc	320,00

Sterowniki • Controllers		
FLEX	EUR/szt. • EUR/pc	260,00
WIFSET		260,00
SA-CONTROL		320,00

*) wartości mierzone w punkcie pracy • value at the working point

**) nagrzewnica montowana na kanale (dopłata) • heater on canal (additional payment)

Ceny przeliczone na PLN w dniu sprzedaży wg kursów średnich NBP.



Centrala wentylacyjna z odzyskiem ciepła

• Air handling unit with heat recovery

RIS HE EKO 3.0

Wymiennik przeciwprądowy: **ODZYSK DO 94%**.

Grubość ścianek: 30-50 mm.

Klasa filtra nawiewnego: F7.

Klasa filtra wywiewnego: F5.

Silniki EC.

Automatyka sterowania.

Regulowana wydajność powietrza i temperatura powietrza nawiewanego.

*Counter-flow heat exchanger: RECUPERATION UP 94%.**Wall thickness: 30-50 mm.**Supply filter class: F7.**Exhaust filter class: F5.**EC motors.**Integrated control.**Controlled air flow and supply air temperature control.***H** - układ poziomy • horizontal set**E** - nagrzewnica elektryczna • electrical heater

Model	Wydajność/spręż ¹⁾ • Efficiency/Compression range [m ³ /h] / [Pa]	Moc nagrzewnicy • Heater capacity [kW]	Przyłącze • Connection [mm]	Cena katalogowa • Price [EUR/szt.] • [EUR/pc]
RIS 700 HE EKO 3.0	750/100	1,2	Ø 250	3 450,00
RIS 1200 HE EKO 3.0	1200/200	2,0	Ø 315	5 420,00
RIS 1900 HE EKO 3.0	1820/200	3,0	Ø 400	7 710,00
RIS 2200 HE EKO 3.0	2100/200	3,0	Ø 400	8 640,00
RIS 2500 HE EKO 3.0	2700/200	3,6	600×350	9 900,00
RIS 3500 HE EKO 3.0	3700/200	6,0	800×500	11 260,00

Sterowniki • Controllers

FLEX	EUR/szt. • EUR/pc	260,00
WIFSET		260,00
SA-CONTROL		320,00

¹⁾ wartości mierzone w punkcie pracy • value at the working point

Ceny przeliczane na PLN w dniu sprzedaży wg kursów średnich NBP.



Centrala wentylacyjna z odzyskiem ciepła

• Air handling unit with heat recovery

RIS HW EKO 3.0

Wymiennik przeciwprądowy: **ODZYSK DO 94%**.

Grubość ścianek: 30-50 mm.

Klasa filtra nawiewnego: F7.

Klasa filtra wywiewnego: F5.

Silniki EC.

Automatyka sterowania.

Regulowana wydajność powietrza i temperatura powietrza nawiewanego.

*Counter-flow heat exchanger: RECUPERATION UP 94%.**Wall thickness: 30-50 mm.**Supply filter class: F7.**Exhaust filter class: F5.**EC motors.**Integrated control.**Controlled air flow and supply air temperature control.***H** - układ poziomy • horizontal set**W** - nagrzewnica wodna • water heater

Model	Wydajność/spręż ¹⁾ • Efficiency/Compression range [m ³ /h] / [Pa]	Moc nagrzewnicy • Heater capacity [kW]	Przyłącze • Connection [mm]	Cena katalogowa • Price [EUR/szt.] • [EUR/pc]
RIS 700 HW EKO 3.0	750/100	AVS 250 ²⁾	Ø 250	3 400,00
RIS 1200 HW EKO 3.0	1200/200	AVS 315 ²⁾	Ø 315	5 240,00
RIS 1900 HW EKO 3.0	1820/200	AVS 400 ²⁾	Ø 400	7 460,00
RIS 2200 HW EKO 3.0	2100/200	AVS 400 ²⁾	Ø 400	8 420,00
RIS 2500 HW EKO 3.0	2700/200	SVS 600×350 ²⁾	600×350	9 780,00
RIS 3500 HW EKO 3.0	3700/200	SVS 800×500 ²⁾	800×500	11 060,00

Zestaw do centrali z nagrzewnicą wodną (zawór + siłownik + śrubunek)		
ZS	EUR/szt. • EUR/pc	320,00

Sterowniki • Controllers		
FLEX	EUR/szt. • EUR/pc	260,00
WIFSET		260,00
SA-CONTROL		320,00

¹⁾ wartości mierzone w punkcie pracy • value at the working point²⁾ nagrzewnica montowana na kanale (dopłata) • heater on canal (additional payment)

Ceny przeliczone na PLN w dniu sprzedaży wg kursów średnich NBP.



Centrala wentylacyjna z odzyskiem ciepła

• Air handling unit with heat recovery

RIS PE EKO 3.0

Program dorobowy:
select.salda.it

P - podsufitowe • under-ceiling

E - nagrzewnica elektryczna • electrical heater

Wymiennik przeciwprądowy: **ODZYSK DO 94%**.

Grubość ścianek: 30-50 mm.

Klasa filtra nawiewnego: F7.

Klasa filtra wyciągowego: F5.

Silniki EC.

Automatyka sterowania.

Regulowana wydajność powietrza i temperatura powietrza nawiewanego.

Counter-flow heat exchanger: RECOVERY UP 94%.

Wall thickness: 30-50 mm.

Supply filter class: F7.

Exhaust filter class: F5.

EC motors.

Integrated control.

Controlled air flow and supply air temperature control.

Model	Wydajność/spręż ¹⁾ • Efficiency/Compression range [m ³ /h] / [Pa]	Moc nagrzewnicy • Heater capacity [kW]	Przyłącze • Connection [mm]	Cena katalogowa • Price [EUR/szt.] • [EUR/pc]
RIS 400 PE 0.9 EKO 3.0 RIS 400 PE 1.6 EKO 3.0 RIS 400 PE 3.0 EKO 3.0	390/200	0,9 1,6 3,0	Ø 200	3 050,00 3 110,00 3 260,00
RIS 700 PE 1.2 EKO 3.0 RIS 700 PE 3.0 EKO 3.0 RIS 700 PE 4.5 EKO 3.0	650/200	1,2 3,0 4,5	Ø 250	3 440,00 3 520,00 3 620,00
RIS 1200 PE 3.0 EKO 3.0 RIS 1200 PE 6.0 EKO 3.0 RIS 1200 PE 9.0 EKO 3.0	1200/200	3,0 6,0 9,0	500×250	5 860,00 6 100,00 6 140,00
RIS 1900 PE 3.0 EKO 3.0 RIS 1900 PE 6.0 EKO 3.0 RIS 1900 PE 12.0 EKO 3.0	1700/200	3,0 6,0 12,0	700×300	8 240,00 8 370,00 8 620,00
RIS 2500 PE 4.5 EKO 3.0 RIS 2500 PE 9.0 EKO 3.0 RIS 2500 PE 18.0 EKO 3.0	2400/200	4,5 9,0 18,0	700×400	9 620,00 9 760,00 10 060,00

Sterowniki • Controllers		
FLEX	EUR/szt. • EUR/pc	260,00
WIFSET		260,00
SA-CONTROL		320,00

¹⁾ wartości mierzone w punkcie pracy • value at the working point

Ceny przeliczane na PLN w dniu sprzedaży wg kursów średnich NBP.



Centrala wentylacyjna z odzyskiem ciepła

• Air handling unit with heat recovery

RIS PW EKO 3.0

Program dorobowy:
select.salda.it

P - podsufitowe • under-ceiling

W - nagrzewnica wodna • water heater

Wymiennik przeciwprądowy: **ODZYSK DO 94%**.

Grubość ścianek: 30-50 mm.

Klasa filtra nawiewnego: F7.

Klasa filtra wywiewnego: F5.

Silniki EC.

Automatyka sterowania.

Regulowana wydajność powietrza i temperatura powietrza nawiewanego.

Counter-flow heat exchanger: RECOVERY UP 94%.

Wall thickness: 30-50 mm.

Supply filter class: F7.

Exhaust filter class: F5.

EC motors.

Integrated control.

Controlled air flow and supply air temperature control.

Model	Wydajność/spręż ¹⁾ • Efficiency/Compression range [m ³ /h] / [Pa]	Moc nagrzewnicy • Heater capacity [kW]	Przyłącze • Connection [mm]	Cena katalogowa • Price [EUR/szt.] • [EUR/pc]
RIS 400 PW EKO 3.0	400/200	AVS 200 ²⁾	Ø 200	3 260,00
RIS 700 PW EKO 3.0	700/200	AVS 250 ²⁾	Ø 250	3 390,00
RIS 1200 PW EKO 3.0	1200/200	SVS 500×250 ²⁾	500×250	5 920,00
RIS 1900 PW EKO 3.0	1700/200	SVS 700×400 ²⁾	700×400	8 100,00
RIS 2500 PW EKO 3.0	2400/200	SVS 700×400 ²⁾	700×400	9 490,00

Zestaw do centrali z nagrzewnicą wodną (zawór + siłownik + śrubunek)		
ZS	EUR/szt. • EUR/pc	320,00

Sterowniki • Controllers		
FLEX	EUR/szt. • EUR/pc	260,00
WIFSET		260,00
SA-CONTROL		320,00

¹⁾ wartości mierzone w punkcie pracy • value at the working point²⁾ nagrzewnica montowana na kanale (dopłata) • heater on canal (additional payment)

Ceny przeliczane na PLN w dniu sprzedaży wg kursów średnich NBP.



Centrala wentylacyjna z odzyskiem ciepła

• Air handling unit with heat recovery

RIRS VE EKO 3.0

Program dorobowy:
select.salda.itWymiennik obrotowy: **ODZYSK DO 80%**.

Grubość ścianek: 20-50 mm.

Klasa filtra nawiewnego: F7.

Klasa filtra wywiewnego: F5.

Silniki EC.

Automatyka sterowania.

Regulowana wydajność powietrza i temperatura powietrza nawiewanego.

Rotor heat exchanger: *RECUPERATION UP 80%*.

Wall thickness: 20-50 mm.

Supply filter class: F7.

Exhaust filter class: F5.

EC motors.

Integrated control.

Controlled air flow and supply air temperature control.

V - układ pionowy • vertical set

E - nagrzewnica elektryczna • electric heater

Model	Wydajność/spręż ¹⁾ • Efficiency/Compression range [m ³ /h] / [Pa]	Moc nagrzewnicy • Heater capacity [kW]	Przyłącze • Connection [mm]	Cena katalogowa • Price [EUR/szt.] • [EUR/pc]
RIRS 400 VE EKO 3.0	400/150	1,2	Ø 160	2 400,00
RIRS 700 VE EKO 3.0	750/150	2,0	Ø 250	3 330,00
RIRS 1200 VE EKO 3.0	1350/200	4,5	Ø 315	5 420,00
RIRS 1900 VE EKO 3.0	1850/200	9,0	Ø 315	5 870,00
RIRS 2500 VE EKO 3.0	2500/200	9,0	500×250	9 330,00
RIRS 3500 VE EKO 3.0	3500/200	12,0	600×300	11 260,00
RIRS 5500 VE EKO 3.0	6000/250	18,0	900×300	14 670,00

Sterowniki • Controllers		
FLEX	EUR/szt. • EUR/pc	260,00
WIFSET		260,00
SA-CONTROL		320,00

¹⁾ wartości mierzone w punkcie pracy • value at the working point

Ceny przeliczane na PLN w dniu sprzedaży wg kursów średnich NBP.



Centrala wentylacyjna z odzyskiem ciepła

• Air handling unit with heat recovery

RIRS VW EKO 3.0

Program dorobowy:
select.salda.itWymiennik obrotowy: **ODZYSK DO 80%**.

Grubość ścianek: 20-50 mm.

Klasa filtra nawiewnego: F5/F7.

Klasa filtra wyciągowego: F5.

Silniki EC.

Automatyka sterowania.

Regulowana wydajność powietrza i temperatura powietrza nawiewanego.

Rotor heat exchanger: *RECUPERATION UP 80%*.

Wall thickness: 20-50 mm.

Supply filter class: F5/F7.

Exhaust filter class: F5.

EC motors.

Integrated control.

Controlled air flow and supply air temperature control.

V - układ pionowy • vertical set

W - nagrzewnica wodna • water heater

Model	Wydajność/spręż ¹⁾ • Efficiency/Compression range [m ³ /h] / [Pa]	Moc nagrzewnicy • Heater capacity [kW]	Przyłącze • Connection [mm]	Cena katalogowa • Price [EUR/szt.] • [EUR/pc]
RIRS 400 VW EKO 3.0	400/200	AVS 160 ²⁾	Ø 160	2 410,00
RIRS 700 VW EKO 3.0	750/150	AVS 250 ²⁾	Ø 250	3 250,00
RIRS 1200 VW EKO 3.0	1350/200	AVS 315 ²⁾	Ø 315	5 300,00
RIRS 1900 VW EKO 3.0	1850/200	AVS 315 ²⁾	Ø 315	5 800,00
RIRS 2500 VW EKO 3.0	2500/200	SVS 500×250 ²⁾	500×250	8 990,00
RIRS 3500 VW EKO 3.0	3500/200	SVS 600×300 ²⁾	600×300	10 690,00
RIRS 5500 VW EKO 3.0	6000/250	SVS 800×500 ²⁾	900×300	14 440,00

Zestaw do centrali z nagrzewnicą wodną (zawór + siłownik + śrubunek)		
ZS	EUR/szt. • EUR/pc	320,00

Sterowniki • Controllers		
FLEX	EUR/szt. • EUR/pc	260,00
WIFSET		260,00
SA-CONTROL		320,00

¹⁾ wartości mierzone w punkcie pracy • value at the working point²⁾ nagrzewnica montowana na kanale (dopłata) • heater on canal (additional payment)

Ceny przeliczone na PLN w dniu sprzedaży wg kursów średnich NBP.



Centrala wentylacyjna z odzyskiem ciepła

• Air handling unit with heat recovery

RIRS HE EKO 3.0

Wymiennik obrotowy: **ODZYSK DO 80%**.

Grubość ścianek: 50 mm.

Klasa filtra nawiewnego: F7.

Klasa filtra wywiewnego: F5.

Silniki EC.

Automatyka sterowania.

Regulowana wydajność powietrza i temperatura powietrza nawiewanego.

Rotor heat exchanger: *RECUPERATION UP 80%*.

Wall thickness: 50 mm.

Supply filter class: F7.

Exhaust filter class: F5.

EC motors.

Integrated control.

Controlled air flow and supply air temperature control.

H - układ poziomy • horizontal set**E** - nagrzewnica elektryczna • electric heater

Model	Wydajność/spręż ¹⁾ • Efficiency/Compression range [m ³ /h] / [Pa]	Moc nagrzewnicy • Heater capacity [kW]	Przyłącze • Connection [mm]	Cena katalogowa • Price [EUR/szt.] • [EUR/pc]
RIRS 400 HE EKO 3.0	450/150	1,2	Ø 200	2 160,00
RIRS 700 HE EKO 3.0	650/180	2,0	Ø 250	2 990,00
RIRS 1200 HE EKO 3.0	1350/200	4,0	Ø 315	5 350,00
RIRS 1900 HE EKO 3.0	1800/180	9,0	Ø 315	5 740,00
RIRS 2500 HE EKO 3.0	2500/240	9,0	700×400	10 010,00
RIRS 3500 HE EKO 3.0	4100/200	12,0	700×400	12 280,00
RIRS 5500 HE EKO 3.0	6000/270	15,0	800×500	14 790,00

Sterowniki • Controllers		
FLEX	EUR/szt. • EUR/pc	260,00
WIFSET		260,00
SA-CONTROL		320,00

¹⁾ wartości mierzone w punkcie pracy • value at the working point

Ceny przeliczane na PLN w dniu sprzedaży wg kursów średnich NBP.

Centrala wentylacyjna z odzyskiem ciepła

• Air handling unit with heat recovery

RIRS HW EKO 3.0

Program dorobowy:
select.salda.itWymiennik obrotowy: **ODZYSK DO 80%**.

Grubość ścianek: 50 mm.

Klasa filtra nawiewnego: F7.

Klasa filtra wywiewnego: F5.

Silniki EC.

Automatyka sterowania.

Regulowana wydajność powietrza i temperatura powietrza nawiewanego.

Rotor heat exchanger: *RECUPERATION UP 80%*.

Wall thickness: 50 mm.

Supply filter class: F7.

Exhaust filter class: F5.

EC motors.

Integrated control.

Controlled air flow and supply air temperature control.

H - układ poziomy • horizontal set

W - nagrzewnica wodna • water heater

Model	Wydajność/spręż ¹⁾ • Efficiency/Compression range [m ³ /h] / [Pa]	Moc nagrzewnicy • Heater capacity [kW]	Przyłącze • Connection [mm]	Cena katalogowa • Price [EUR/szt.] • [EUR/pc]
RIRS 400 HW EKO 3.0	450/150	AVS 200 ^{*)}	Ø 200	2 270,00
RIRS 700 HW EKO 3.0	650/180	AVS 250 ^{*)}	Ø 250	2 970,00
RIRS 1200 HW EKO 3.0	1350/200	AVS 315 ^{*)}	Ø 315	5 280,00
RIRS 1900 HW EKO 3.0	1800/180	AVS 315 ^{*)}	Ø 315	5 690,00
RIRS 2500 HW EKO 3.0	2500/240	Comfort Box 600×350 ^{*)}	700×400	9 780,00
RIRS 3500 HW EKO 3.0	4100/200	Comfort Box 800×500 ^{*)}	700×400	11 940,00
RIRS 5500 HW EKO 3.0	6000/270	Comfort Box 800×500 ^{**)}	800×500	14 100,00

Zestaw do centrali z nagrzewnicą wodną (zawór + siłownik + śrubunek)		
ZS	EUR/szt. • EUR/pc	320,00

Sterowniki • Controllers		
FLEX	EUR/szt. • EUR/pc	260,00
WIFSET		260,00
SA-CONTROL		320,00

¹⁾ wartości mierzone w punkcie pracy • value at the working point^{**)} nagrzewnica montowana na kanale (dopłata) • heater on canal (additional payment)

Ceny przeliczane na PLN w dniu sprzedaży wg kursów średnich NBP.



Centrala wentylacyjna z odzyskiem ciepła

• Air handling unit with heat recovery

RIRS PE EKO 3.0

**P** - podsufitowe • under-ceiling**E** - nagrzewnica elektryczna • electrical heaterWymiennik obrotowy: **ODZYSK DO 90%**.

Grubość ścianek: 30 mm.

Klasa filtra nawiewnego: F7.

Klasa filtra wywiewnego: M5.

Silniki EC.

Automatyka sterowania.

Regulowana wydajność powietrza i temperatura powietrza nawiewanego.

Rotor heat exchanger: *RECUPERATION UP 80%*.

Wall thickness: 30 mm.

Supply filter class: F7.

Exhaust filter class: F5.

EC motors.

Integrated control.

Controlled air flow and supply air temperature control.

Model	Wydajność/spręż ¹⁾ • Efficiency/Compression range [m ³ /h] / [Pa]	Moc nagrzewnicy • Heater capacity [kW]	Przyłącze • Connection [mm]	Cena katalogowa • Price [EUR/szt.] • [EUR/pc]
RIRS 350 PE EKO 3.0	300/100	0,6	Ø 200	2 120,00

Sterowniki • Controllers		
FLEX	EUR/szt. • EUR/pc	260,00
WIFSET		260,00
SA-CONTROL		320,00

¹⁾ wartości mierzone w punkcie pracy • value at the working point

Ceny przeliczone na PLN w dniu sprzedaży wg kursów średnich NBP.



Centrala wentylacyjna z odzyskiem ciepła

• Air handling unit with heat recovery

RIRS PW EKO 3.0

**P** - podsufitowe • under-ceiling**W** - nagrzewnica wodna • water heaterWymiennik obrotowy: **ODZYSK DO 90%**.

Grubość ścianek: 30 mm.

Klasa filtra nawiewnego: F7.

Klasa filtra wywiewnego: M5.

Silniki EC.

Automatyka sterowania.

Regulowana wydajność powietrza i temperatura powietrza nawiewanego.

Rotor heat exchanger: *RECUPERATION UP 80%*.

Wall thickness: 50 mm.

Supply filter class: F7.

Exhaust filter class: F5.

EC motors.

Integrated control.

Controlled air flow and supply air temperature control.

Model	Wydajność/spręż ¹⁾ • Efficiency/Compression range [m ³ /h] / [Pa]	Moc nagrzewnicy • Heater capacity [kW]	Przyłącze • Connection [mm]	Cena katalogowa • Price [EUR/szt.] • [EUR/pc]
RIRS 350 PW EKO 3.0	300/100	AVS 200 ²⁾	Ø 200	2 070,00

Zestaw do centrali z nagrzewnicą wodną (zawór + siłownik + śrubunek)		
ZS	EUR/szt. • EUR/pc	320,00

Sterowniki • Controllers		
FLEX	EUR/szt. • EUR/pc	260,00
WIFSET		260,00
SA-CONTROL		320,00

¹⁾ wartości mierzone w punkcie pracy • value at the working point²⁾ nagrzewnica montowana na kanale (dopłata) • heater on canal (additional payment)

Ceny przeliczone na PLN w dniu sprzedaży wg kursów średnich NBP.



Czujnik wilgotności • Humidity sensor

Typ • Type	Cena [EUR/szt.] • Price [EUR/pc]
S-RFF-U-D-F2 POMIESZCZENIE • ROOM	170,00

Typ • Type	Cena [EUR/szt.] • Price [EUR/pc]
S-KFF-U KANAL • DUCT	200,00

Czujniki CO₂ • CO₂ sensor

Typ • Type	Cena [EUR/szt.] • Price [EUR/pc]
S-RCO2-F2 POMIESZCZENIE • ROOM	310,00

Regulator tyrystorowy • Fan speed controller

Typ • Type	Cena [EUR/szt.] • Price [EUR/pc]
ETY-1,5	40,00
ETY-2,5	50,00

Typ • Type	Cena [EUR/szt.] • Price [EUR/pc]
SDY-1,5	50,00
SDY-3,0	60,00

Regulator transformatorowy 400V • Fan speed controller

TGRT

Typ • Type	Cena [EUR/szt.] • Price [EUR/pc]
TGRT 1	210,00
TGRT 2	240,00
TGRT 3	290,00
TGRT 4	340,00

Typ • Type	Cena [EUR/szt.] • Price [EUR/pc]
TGRT 5	390,00
TGRT 7	460,00
TGRT 11	560,00
TGRT 14	590,00

Regulator transformatorowy 230V • Fan speed controller

TGRV

Typ • Type	Cena [EUR/szt.] • Price [EUR/pc]
TGRV 1.5	120,00
TGRV 2	120,00
TGRV 3	140,00
TGRV 4	140,00

Typ • Type	Cena [EUR/szt.] • Price [EUR/pc]
TGRV 5	160,00
TGRV 7	190,00
TGRV 11	220,00
TGRV 14	250,00

Ceny przeliczane na PLN w dniu sprzedaży wg kursów średnich NBP.



Daszek • Roof	
Typ • Type	Cena [EUR/szt.] • Price [EUR/pc]
dla • for: RIS 1200 H EKO	190,00
dla • for: RIS 1900/2200 H EKO	200,00
dla • for: RIS 2500 H EKO	220,00
dla • for: RIS 3500 H EKO	230,00
dla • for: RIRS 1200/1900 H EKO	110,00
dla • for: RIRS 2500 H EKO	140,00
dla • for: RIRS 3500 H EKO	190,00
dla • for: RIRS 5500 H EKO	220,00

Nóżki • Support	
Typ • Type	Cena [EUR/szt.] • Price [EUR/pc]
dla • for: Smarty 2X P	50,00
dla • for: Smarty 2X/3X/4X V	50,00
dla • for: Smarty 3X/4X P	50,00

Ceny przeliczane na PLN w dniu sprzedaży wg kursów średnich NBP.

Filtry do central wentylacyjnych • Filters for air handling units
FMK

Typ • Type	Cena [EUR/szt.] • Price [EUR/pc]
FMK 100/Coarse-75	10,00
FMK 100/ePM10-65	10,00
FMK 100/ePM1-55	20,00
FMK 125/Coarse-75	10,00
FMK 125/ePM10-65	10,00
FMK 125/ePM1-55	20,00
FMK 160/Coarse-75	10,00
FMK 160/ePM10-65	20,00
FMK 160/ePM1-55	20,00
FMK 200/Coarse-75	20,00
FMK 200/ePM10-65	20,00
FMK 200/ePM1-55	20,00
FMK 250/Coarse-75	20,00
FMK 250/ePM10-65	20,00
FMK 250/ePM1-55	20,00
FMK 315/Coarse-75	20,00
FMK 315/ePM10-65	30,00
FMK 315/ePM1-55	40,00
FMK 355/Coarse-75	30,00
FMK 355/ePM10-65	40,00
FMK 355/ePM1-55	50,00
FMK 400/Coarse-75	30,00
FMK 400/ePM10-65	40,00
FMK 400/ePM1-55	50,00
FMK 500/Coarse-75	40,00
FMK 500/ePM10-65	50,00
FMK 500/ePM1-55	80,00

Typ • Type	Cena [EUR/szt.] • Price [EUR/pc]
FMK 630/Coarse-75	50,00
FMK 630/ePM10-65	70,00
FMK 630/ePM1-55	140,00
FMK 40-20/Coarse-75	20,00
FMK 40-20/ePM10-65	20,00
FMK 40-20/ePM1-55	20,00
FMK 50-25/Coarse-75	20,00
FMK 50-25/ePM10-65	20,00
FMK 50-25/ePM1-55	40,00
FMK 50-30/Coarse-75	20,00
FMK 50-30/ePM10-65	20,00
FMK 50-30/ePM1-55	40,00
FMK 60-30/Coarse-75	20,00
FMK 60-30/ePM10-65	30,00
FMK 60-30/ePM1-55	40,00
FMK 60-35/Coarse-75	30,00
FMK 60-35/ePM10-65	30,00
FMK 60-35/ePM1-55	50,00
FMK 70-40/Coarse-75	30,00
FMK 70-40/ePM10-65	40,00
FMK 70-40/ePM1-55	90,00
FMK 80-50/Coarse-75	50,00
FMK 80-50/ePM10-65	60,00
FMK 80-50/ePM1-55	120,00
FMK 100-50/Coarse-75	50,00
FMK 100-50/ePM10-65	60,00
FMK 100-50/ePM1-55	130,00

Ceny przeliczane na PLN w dniu sprzedaży wg kursów średnich NBP.



FDI

Typ • Type	Cena [EUR/szt.] • Price [EUR/pc]
FDI 100/Coarse-75	60,00
FDI 100/ePM10-65	60,00
FDI 100/ePM1-55	60,00
FDI 125/Coarse-75	60,00
FDI 125/ePM10-65	60,00
FDI 125/ePM1-55	60,00
FDI 160/Coarse-75	70,00
FDI 160/ePM10-65	70,00
FDI 160/ePM1-55	70,00
FDI 200/Coarse-75	70,00
FDI 200/ePM10-65	70,00
FDI 200/ePM1-55	80,00
FDI 250/Coarse-75	80,00
FDI 250/ePM10-65	80,00
FDI 250/ePM1-55	80,00

Typ • Type	Cena [EUR/szt.] • Price [EUR/pc]
FDI 315/Coarse-75	90,00
FDI 315/ePM10-65	90,00
FDI 315/ePM1-55	100,00
FDI 355/Coarse-75	100,00
FDI 355/ePM10-65	100,00
FDI 355/ePM1-55	100,00
FDI 400/Coarse-75	100,00
FDI 400/ePM10-65	110,00
FDI 400/ePM1-55	110,00
FDI 500/Coarse-75	120,00
FDI 500/ePM10-65	120,00
FDI 500/ePM1-55	120,00
FDI 630/Coarse-75	180,00
FDI 630/ePM10-65	180,00
FDI 630/ePM1-55	190,00

FD

Typ • Type	Cena [EUR/szt.] • Price [EUR/pc]
FD 100/Coarse-75	40,00
FD 125/Coarse-75	40,00
FD 160/Coarse-75	40,00
FD 200/Coarse-75	40,00
FD 250/Coarse-75	50,00
FD 315/Coarse-75	50,00
FD 355/Coarse-75	50,00
FD 400/Coarse-75	60,00
FD 500/Coarse-75	60,00
FD 630/Coarse-75	80,00

FM

Typ • Type	Cena [EUR/szt.] • Price [EUR/pc]
FM 100-125-160/Coarse-75	10,00
FM 200/Coarse-75	10,00
FM 250/Coarse-75	10,00
FM 315/Coarse-75	10,00
FM 355/Coarse-75	10,00
FM 400/Coarse-75	10,00
FM 500/Coarse-75	10,00
FM 630/Coarse-75	20,00

Ceny przeliczane na PLN w dniu sprzedaży wg kursów średnich NBP.



Centrale wentylacyjne Vent-Axia KINETIC ADVANCE

• Vent-Axia KINETIC ADVANCE air handling units

- wydajność: 350 m³/h (domy do 180 m²)
- wymiennik przeciwprądowy (odzysk ciepła do 94%)
- oszczędne silniki prądu stałego EBM PAPST
- sterownik z ekranem dotykowym na obudowie
- kontrola przez Wi-Fi i aplikację mobilną
- do wyboru filtry klasy G3, M5 lub F7
- kompaktowe wymiary

- efficiency: 350 m³/h (houses up to 180 m²)
- counter-current exchanger (heat recovery up to 94%)
- advanced EBM PAPST EC fans
- touch screen controller on casing
- Wi-Fi control with mobile app
- G3, M5 and F7 filter options
- lightweight and compact size

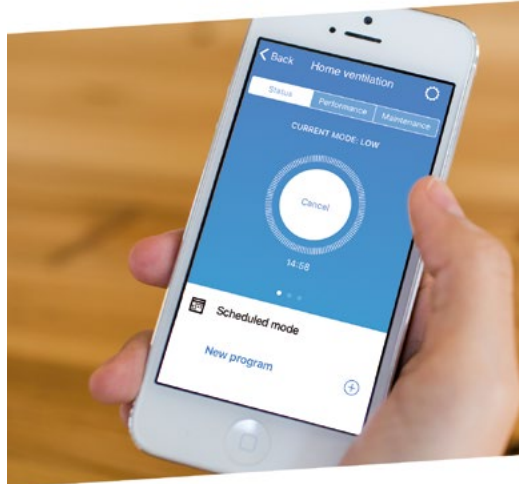

Model	Wydajność/spręż ¹⁾ • Efficiency/Compression range [m ³ /h] / [Pa]	Wymiary ²⁾ • Unit size [mm]	Przyłącze • Connection [mm]	Zasilanie • Supply voltage [V/Hz]	Cena [EUR/szt.] • Price [EUR/pc]
Kinetic Advance S	370 / 100	660×760×443	125	230/50	2 080,00

Moduł Wi-Fi	EUR/szt. • EUR/pc	160,00
Uchwyt do sterownika		100,00

¹⁾ wartości mierzone w punkcie pracy • value at the working point

²⁾ szerokość × wysokość × długość • width × height × length

Ceny przeliczane na PLN w dniu sprzedaży wg kursów średnich NBP.

Centrale wentylacyjne Vent-Axia KINETIC (PLUS) • Vent-Axia KINETIC (PLUS) air handling units

- wymiennik krzyżowy przeciwprądowy - **ODZYSK do 92%**
- wydajności: Kinetik - 250 m³/h, Kinetik Plus - 400 m³/h
- nisko-energetyczne silniki prądu stałego EC/DC
- łatwa wymiana filtrów bez konieczności zdejmowania panelu przedniego
- możliwość zmiany kierunku otworów przyłączeniowych: wersja pionowa/pozioma
- zdolność do podłączenia BMS
- regulowany opóźnieniowy włącznik/wyłącznik czasowy
- counterflow plate heat exchanger - RECOVERY to 92%
- efficiency: Kinetik - 250 m³/h, Kinetik Plus - 400 m³/h
- low energy EC/DC motors
- easy to change filters, without removing the front panel
- horizontal and/or vertical duct outlets
- BMS connectivity
- adjustable delay on/delay off timer



Kinetik B



Kinetik B Plus

Model	Wydajność/spręż ¹⁾ • Efficiency/Compression range [m ³ /h] / [Pa]	Wymiary ²⁾ • Unit size [mm]	Przyłącze • Connection [mm]	Zasilanie • Supply voltage [V/Hz]	Cena [EUR/szt.] • Price [EUR/pc]
Kinetik B	250/90	550×650×285	125	230/50	1 550,00
Kinetik B Plus	400/150	785×747×526	150	230/50	2 100,00

DUBLER - sterownik na kablu	EUR/szt. • EUR/pc	110,00
------------------------------------	-------------------	--------

¹⁾ wartości mierzone w punkcie pracy • value at the working point

²⁾ szerokość × wysokość × długość • width × height × length

Ceny przeliczane na PLN w dniu sprzedaży wg kursów średnich NBP.



Nagrzewnica wodna • Water heater

AVS



Typ • Type	Cena [EUR/szt.] • Price [EUR/pc]
AVS 100	190,00
AVS 125	200,00
AVS 160	240,00
AVS 200	250,00

Typ • Type	Cena [EUR/szt.] • Price [EUR/pc]
AVS 250	310,00
AVS 315	400,00
AVS 400	490,00
AVS 500	570,00

Nagrzewnica wodna kanałowa prostokątna • Heating coil for rectangular ducting

SVS

Typ • Type	Cena [EUR/szt.] • Price [EUR/pc]
SVS 400x200-2	240,00
SVS 400x200-4	330,00
SVS 500x250-2	310,00
SVS 500x250-4	430,00
SVS 500x300-2	340,00
SVS 500x300-4	460,00
SVS 600x300-2	370,00
SVS 600x300-4	530,00
SVS 600x350-2	390,00
SVS 600x350-4	540,00

Typ • Type	Cena [EUR/szt.] • Price [EUR/pc]
SVS 700x400-2	460,00
SVS 700x400-4	680,00
SVS 800x500-2	610,00
SVS 800x500-4	920,00
SVS 1000x500-2	680,00
SVS 1000x500-4	1 110,00
SVS-V 500x250-2	380,00
SVS-V 600x300-2	410,00
SVS-V 900x300-2	480,00

Chłodnica wodna • Water cooler

AVA



Typ • Type	Cena [EUR/szt.] • Price [EUR/pc]
AVA 100	310,00
AVA 125	310,00
AVA 160	320,00
AVA 200	400,00
AVA 250	480,00

Typ • Type	Cena [EUR/szt.] • Price [EUR/pc]
AVA 315	570,00
AVA 400	740,00
AVA 500	1 450,00
AVA 630	2 050,00
AVA 710	2 940,00

Ceny przeliczone na PLN w dniu sprzedaży wg kursów średnich NBP.



Chłodnica freonowa okrągła • Freon cooler

AVA-DX



Typ • Type	Cena [EUR/szt.] • Price [EUR/pc]
AVA-DX 315	820,00
AVA-DX 400	890,00
AVA-DX 500	1 280,00
AVA-DX 630	1 980,00
AVA-DX 710	3 490,00

Chłodnica freonowa prostokątna / okrągła • Freon cooler

SVF



Typ • Type	Cena [EUR/szt.] • Price [EUR/pc]
SVF 400x200	580,00
SVF 500x250	690,00
SVF 500x300	810,00
SVF 600x300	870,00

Typ • Type	Cena [EUR/szt.] • Price [EUR/pc]
SVF 600x350	980,00
SVF 700x400	1 290,00
SVF 800x500	1 620,00
SVF 1000x500	1 790,00

Ceny przeliczane na PLN w dniu sprzedaży wg kursów średnich NBP.



Nagrzewnica kanałowa elektryczna		EKA			
Typ	Cena [EUR/szt.]	Typ	Cena [EUR/szt.]		
100-0.3-1f	70,00	200-2.4-1f	110,00	315-3.0-3f	150,00
100-0.6-1f	70,00	200-3.0-1f	120,00	315-4.5-1f	180,00
100-0.9-1f	90,00	200-3.0-2f	120,00	315-5.0-1f	180,00
100-1.2-1f	100,00	200-3.0-3f	130,00	315-5.0-2f	180,00
100-1.5-1f	110,00	200-5.0-1f	160,00	315-6.0-2f	180,00
100-1.8-1f	120,00	200-5.0-2f	150,00	315-6.0-3f	200,00
125-0.3-1f	70,00	200-6.0-1f	160,00	315-9.0-3f	210,00
125-0.6-1f	80,00	200-6.0-2f	170,00	315-12.0-3f	270,00
125-0.9-1f	90,00	200-6.0-3f	170,00	315-15.0-3f	320,00
125-1.2-1f	100,00	200-9.0-3f	180,00	315-18.0-3f	340,00
125-1.5-1f	110,00	250-0.3-1f	80,00	355-6.0-3f	210,00
125-1.8-1f	120,00	250-0.6-1f	100,00	355-9.0-3f	220,00
125-2.4-1f	130,00	250-0.9-1f	110,00	355-12.0-3f	290,00
125-3.0-1f	130,00	250-1.0-1f	90,00	355-15.0-3f	330,00
160-0.3-1f	80,00	250-1.2-1f	90,00	400-3.0-1f	150,00
160-0.6-1f	80,00	250-1.5-1f	100,00	400-3.0-2f	150,00
160-0.9-1f	90,00	250-2.0-1f	110,00	400-3.0-3f	150,00
160-1.0-1f	80,00	250-2.4-1f	110,00	400-5.0-1f	190,00
160-1.2-1f	90,00	250-3.0-1f	120,00	400-5.0-2f	190,00
160-1.5-1f	90,00	250-3.0-2f	120,00	400-6.0-2f	180,00
160-1.8-1f	90,00	250-3.0-3f	120,00	400-6.0-3f	200,00
160-2.0-1f	90,00	250-4.8-3f	170,00	400-9.0-3f	220,00
160-2.1-1f	100,00	250-5.0-1f	150,00	400-12.0-3f	280,00
160-2.4-1f	90,00	250-5.0-2f	150,00	400-15.0-3f	340,00
160-3.0-1f	100,00	250-6.0-1f	170,00	400-18.0-3f	360,00
160-3.0-2f	100,00	250-6.0-2f	120,00	400-24.0-3f	470,00
160-3.0-3f	110,00	250-6.0-3f	170,00	500-3.0-1f	180,00
160-5.0-1f	130,00	250-9.0-3f	150,00	500-3.0-2f	180,00
160-5.0-2f	130,00	315-0.6-1f	120,00	500-4.0-1f	200,00
160-6.0-2f	150,00	315-1.0-1f	110,00	500-5.0-2f	220,00
160-6.0-3f	150,00	315-1.2-1f	110,00	500-6.0-2f	230,00
200-0.3-1f	80,00	315-1.5-1f	120,00	500-6.0-3f	260,00
200-0.6-1f	90,00	315-1.8-1f	140,00	500-9.0-3f	280,00
200-0.9-1f	110,00	315-2.0-1f	120,00	500-12.0-3f	300,00
200-1.0-1f	80,00	315-2.4-1f	130,00	500-15.0-3f	370,00
200-1.2-1f	90,00	315-3.0-1f	150,00	500-18.0-3f	410,00
200-1.5-1f	100,00	315-3.0-2f	140,00	500-21.0-3f	430,00
200-2.0-1f	100,00				

Ceny przeliczone na PLN w dniu sprzedaży wg kursów średnich NBP.



Nagrzewnica kanałowa elektryczna

EKA NV PTC-PS

Nagrzewnica EKA NV z zabudowanym presostatem na obudowie.

Typ	Cena [EUR/szt.]
100-0.3-1f	240,00
100-0.6-1f	240,00
100-0.9-1f	270,00
100-1.2-1f	280,00
125-0.6-1f	250,00
125-0.9-1f	270,00
125-1.2-1f	280,00
125-1.5-1f	290,00
125-1.8-1f	300,00
125-2.4-1f	300,00
160-0.9-1f	270,00
160-1.2-1f	250,00
160-1.5-1f	260,00
160-1.6-1f	280,00
160-2.0-1f	280,00
160-2.4-1f	280,00
160-3.0-1f	290,00
160-3.0-2f	300,00
160-3.0-3f	300,00
160-5.0-2f	330,00
160-6.0-2f	360,00
200-0.9-1f	290,00
200-1.2-1f	270,00
200-1.6-1f	280,00
200-2.0-1f	300,00
200-3.0-1f	320,00
200-3.0-2f	330,00

Typ	Cena [EUR/szt.]
200-3.0-3f	340,00
200-5.0-2f	350,00
200-6.0-2f	370,00
200-6.0-3f	390,00
250-1.2-1f	260,00
250-1.5-1f	280,00
250-2.0-1f	300,00
250-3.0-1f	330,00
250-3.0-2f	340,00
250-3.0-3f	340,00
250-3.6-1f	350,00
250-5.0-1f	360,00
250-5.0-2f	360,00
250-6.0-2f	360,00
250-6.0-3f	400,00
250-9.0-3f	420,00
315-1.5-1f	300,00
315-2.0-1f	320,00
315-3.0-1f	340,00
315-3.0-2f	340,00
315-3.0-3f	350,00
315-5.0-2f	360,00
315-6.0-2f	380,00
315-6.0-3f	420,00
315-9.0-3f	440,00
315-12.0-3f	540,00

Typ	Cena [EUR/szt.]
315-15.0-3f	560,00
355-3.0-3f	380,00
355-6.0-3f	440,00
355-9.0-3f	460,00
355-12.0-3f	580,00
355-15.0-3f	620,00
400-3.0-1f	320,00
400-3.0-2f	350,00
400-3.0-3f	360,00
400-5.0-2f	370,00
400-6.0-2f	380,00
400-6.0-3f	420,00
400-9.0-3f	460,00
400-12.0-3f	500,00
400-15.0-3f	610,00
400-18.0-3f	720,00
500-3.0-1f	330,00
500-3.0-2f	360,00
500-5.0-2f	390,00
500-6.0-2f	400,00
500-6.0-3f	440,00
500-9.0-3f	490,00
500-12.0-3f	520,00
500-15.0-3f	640,00
500-18.0-3f	770,00
500-21.0-3f	870,00

Ceny przeliczone na PLN w dniu sprzedaży wg kursów średnich NBP.



Nagrzewnica kanałowa elektryczna

EKA NIS

Nagrzewnica z zabudowanym układem regulacyjnym przystosowana do sterowania sygnałem 0...10V.

Typ	Cena [EUR/szt.]
100-0.3-1f	130,00
100-0.6-1f	140,00
100-0.9-1f	160,00
100-1.2-1f	170,00
125-0.3-1f	130,00
125-0.6-1f	150,00
125-0.9-1f	160,00
125-1.2-1f	180,00
125-1.8-1f	180,00
125-2.4-1f	190,00
160-0.3-1f	150,00
160-0.6-1f	150,00
160-0.9-1f	170,00
160-1.0-1f	140,00
160-1.2-1f	140,00
160-1.8-1f	160,00
160-2.0-1f	170,00
160-2.4-1f	180,00
160-3.0-1f	200,00
160-3.0-2f	200,00
160-3.0-3f	200,00
160-5.0-2f	220,00
160-6.0-2f	240,00
160-6.0-3f	270,00
200-0.9-1f	180,00
200-1.2-1f	160,00
200-1.5-1f	170,00
200-2.0-1f	200,00
200-2.4-1f	190,00
200-2.7-1f	240,00

Typ	Cena [EUR/szt.]
200-3.0-1f	210,00
200-3.0-2f	220,00
200-3.0-3f	210,00
200-5.0-2f	230,00
200-6.0-2f	270,00
200-6.0-3f	280,00
250-0.6-1f	160,00
250-1.0-1f	160,00
250-1.2-1f	160,00
250-1.3-1f	170,00
250-1.5-1f	180,00
250-2.0-1f	190,00
250-2.4-1f	200,00
250-3.0-1f	210,00
250-3.0-2f	220,00
250-3.0-3f	220,00
250-5.0-2f	230,00
250-6.0-2f	250,00
250-6.0-3f	290,00
250-9.0-3f	310,00
250-12.0-3f	400,00
315-1.0-1f	180,00
315-1.2-1f	190,00
315-2.0-1f	210,00
315-2.4-1f	230,00
315-2.6-1f	250,00
315-3.0-1f	240,00
315-3.0-2f	230,00
315-3.0-3f	230,00
315-5.0-2f	270,00

Typ	Cena [EUR/szt.]
315-6.0-2f	280,00
315-6.0-3f	310,00
315-9.0-3f	330,00
315-12.0-3f	390,00
355-3.0-3f	270,00
355-6.0-3f	330,00
355-9.0-3f	350,00
355-12.0-3f	420,00
355-15.0-3f	340,00
400-3.0-1f	240,00
400-3.0-2f	250,00
400-3.0-3f	260,00
400-5.0-2f	300,00
400-6.0-1f	320,00
400-6.0-2f	260,00
400-6.0-3f	300,00
400-9.0-3f	350,00
400-12.0-3f	410,00
400-15.0-3f	450,00
400-18.0-3f	540,00
500-3.0-1f	280,00
500-3.0-2f	270,00
500-5.0-2f	290,00
500-6.0-2f	300,00
500-6.0-3f	350,00
500-9.0-3f	390,00
500-12.0-3f	450,00
500-15.0-3f	500,00
500-18.0-3f	580,00
500-21.0-3f	670,00

Ceny przeliczone na PLN w dniu sprzedaży wg kursów średnich NBP.



Nagrzewnica kanałowa elektryczna

EKA NI

Nagrzewnica z zabudowanym układem regulacyjnym (wymagany regulator pomieszczeniowy TR5K).

Typ	Cena [EUR/szt.]
100-0.3-1f	150,00
100-0.6-1f	160,00
100-0.9-1f	180,00
100-1.2-1f	190,00
125-0.3-1f	150,00
125-0.6-1f	160,00
125-0.9-1f	180,00
125-1.2-1f	190,00
125-1.8-1f	220,00
125-2.4-1f	210,00
160-0.3-1f	160,00
160-0.6-1f	170,00
160-0.9-1f	180,00
160-1.0-1f	150,00
160-1.2-1f	160,00
160-1.5-1f	170,00
160-1.6-1f	190,00
160-1.8-1f	180,00
160-2.4-1f	190,00
160-3.0-1f	210,00
160-3.0-2f	220,00
160-5.0-2f	240,00
160-6.0-2f	260,00
160-6.0-3f	290,00
200-0.6-1f	170,00
200-0.9-1f	220,00
200-1.2-1f	180,00
200-2.0-1f	200,00
200-2.4-1f	210,00

Typ	Cena [EUR/szt.]
200-3.0-1f	220,00
200-3.0-2f	230,00
200-3.0-3f	240,00
200-5.0-2f	250,00
200-6.0-2f	290,00
200-6.0-3f	290,00
250-1.2-1f	180,00
250-2.0-1f	210,00
250-2.4-1f	220,00
250-3.0-1f	230,00
250-3.0-2f	230,00
250-3.0-3f	250,00
250-5.0-2f	250,00
250-6.0-2f	250,00
250-6.0-3f	300,00
250-9.0-3f	320,00
250-12.0-3f	420,00
315-1.0-1f	190,00
315-1.2-1f	210,00
315-2.0-1f	220,00
315-2.4-1f	250,00
315-3.0-1f	260,00
315-3.0-2f	240,00
315-3.0-3f	250,00
315-5.0-2f	280,00
315-6.0-2f	290,00
315-6.0-3f	310,00
315-9.0-3f	330,00

Typ	Cena [EUR/szt.]
315-12.0-3f	410,00
315-15.0-3f	430,00
315-18.0-3f	450,00
355-3.0-3f	270,00
355-6.0-3f	340,00
355-9.0-3f	350,00
355-12.0-3f	420,00
355-15.0-3f	460,00
400-3.0-1f	260,00
400-3.0-2f	240,00
400-3.0-3f	270,00
400-5.0-2f	280,00
400-6.0-2f	280,00
400-6.0-3f	320,00
400-9.0-3f	370,00
400-12.0-3f	430,00
400-15.0-3f	470,00
400-18.0-3f	560,00
500-3.0-1f	290,00
500-3.0-2f	280,00
500-5.0-2f	300,00
500-6.0-2f	310,00
500-6.0-3f	350,00
500-9.0-3f	390,00
500-12.0-3f	450,00
500-15.0-3f	500,00
500-18.0-3f	580,00
500-21.0-3f	670,00

Ceny przeliczane na PLN w dniu sprzedaży wg kursów średnich NBP.



Nagrzewnica kanałowa elektryczna prostokątna

EKS

Typ	Cena [EUR/szt.]
400x200/5	260,00
400x200/6	280,00
400x200/9	300,00
400x200/12	360,00
400x200/15	410,00
400x200/21	480,00
500x250/6	290,00
500x250/9	300,00
500x250/12	360,00
500x250/15	410,00
500x250/21	520,00
500x250/24	580,00
500x250/27	640,00
500x250/36	700,00
500x250/45	840,00
500x300/5	280,00
500x300/6	290,00
500x300/9	290,00
500x300/12	350,00
500x300/15	380,00
500x300/18	400,00
500x300/21	470,00
500x300/24	490,00
500x300/27	580,00
500x300/30	610,00
500x300/33	630,00
500x300/36	710,00
500x300/42	750,00
500x300/45	790,00
600x300/9	300,00

Typ	Cena [EUR/szt.]
600x300/12	360,00
600x300/15	390,00
600x300/18	420,00
600x300/21	480,00
600x300/24	500,00
600x300/27	570,00
600x300/30	600,00
600x300/33	630,00
600x300/36	720,00
600x300/42	760,00
600x300/45	820,00
600x350/9	320,00
600x350/12	380,00
600x350/15	400,00
600x350/18	430,00
600x350/21	490,00
600x350/24	510,00
600x350/27	590,00
600x350/30	620,00
600x350/33	650,00
600x350/36	710,00
600x350/42	830,00
600x350/45	900,00
700x400/9	330,00
700x400/12	430,00
700x400/15	440,00
700x400/18	450,00
700x400/24	540,00
700x400/27	610,00
700x400/30	640,00

Typ	Cena [EUR/szt.]
700x400/33	650,00
700x400/36	730,00
700x400/42	810,00
700x400/45	850,00
700x400/51	970,00
700x400/60	1 090,00
700x400/66	1 130,00
700x400/75	1 300,00
700x400/90	1 570,00
800x500/9	360,00
800x500/12	420,00
800x500/15	440,00
800x500/18	470,00
800x500/21	530,00
800x500/24	560,00
800x500/27	610,00
800x500/30	640,00
800x500/33	660,00
800x500/36	740,00
800x500/39	780,00
800x500/42	800,00
800x500/45	850,00
800x500/51	920,00
800x500/54	980,00
800x500/60	1 100,00
800x500/63	1 150,00
800x500/66	1 220,00
800x500/75	1 330,00
800x500/90	1 600,00
1000x500/9	390,00

Ceny przeliczone na PLN w dniu sprzedaży wg kursów średnich NBP.



Typ	Cena [EUR/szt.]
1000x500/12	400,00
1000x500/15	420,00
1000x500/18	440,00
1000x500/24	510,00
1000x500/27	570,00
1000x500/30	680,00

Typ	Cena [EUR/szt.]
1000x500/33	720,00
1000x500/36	770,00
1000x500/39	800,00
1000x500/42	820,00
1000x500/45	890,00
1000x500/51	1 000,00

Typ	Cena [EUR/szt.]
1000x500/54	1 030,00
1000x500/60	1 130,00
1000x500/66	1 180,00
1000x500/75	1 360,00
1000x500/90	1 660,00

Nagrzewnica kanałowa elektryczna prostokątna

EKS NV PTC/PS

Nagrzewnica EKS z okablowaną automatyką i presostatem.

Typ	Cena [EUR/szt.]
400x200/6	460,00
400x200/9	480,00
400x200/12	520,00
400x200/15	570,00
400x200/21	640,00
500x250/3	420,00
500x250/5	450,00
500x250/6	460,00
500x250/9	470,00
500x250/12	520,00
500x250/15	590,00
500x250/21	690,00
500x250/24	750,00
500x250/36	930,00
500x250/45	1 080,00
500x300/6	450,00
500x300/9	470,00
500x300/12	530,00
500x300/15	530,00

Typ	Cena [EUR/szt.]
500x300/18	570,00
500x300/21	620,00
500x300/24	650,00
500x300/27	750,00
500x300/30	780,00
500x300/33	790,00
500x300/36	850,00
500x300/42	910,00
500x300/45	960,00
600x300/6	450,00
600x300/9	460,00
600x300/12	510,00
600x300/15	540,00
600x300/18	570,00
600x300/21	630,00
600x300/24	660,00
600x300/27	720,00
600x300/30	760,00
600x300/33	790,00

Typ	Cena [EUR/szt.]
600x300/36	870,00
600x300/42	960,00
600x300/45	1 020,00
600x350/6	460,00
600x350/9	460,00
600x350/12	530,00
600x350/15	550,00
600x350/18	580,00
600x350/21	640,00
600x350/24	670,00
600x350/27	740,00
600x350/30	770,00
600x350/33	820,00
600x350/36	870,00
600x350/42	940,00
600x350/45	1 000,00
700x300/5	460,00
700x400/6	460,00
700x400/9	520,00

Ceny przeliczane na PLN w dniu sprzedaży wg kursów średnich NBP.



Nagrzewnica kanałowa elektryczna prostokątna		EKS NV PTC/PS			
Typ	Cena [EUR/szt.]	Typ	Cena [EUR/szt.]		
700x400/12	540,00	800x500/18	630,00	1000x500/15	610,00
700x400/15	570,00	800x500/21	690,00	1000x500/18	640,00
700x400/18	610,00	800x500/24	730,00	1000x500/21	700,00
700x400/21	670,00	800x500/27	790,00	1000x500/24	720,00
700x400/24	700,00	800x500/30	820,00	1000x500/27	790,00
700x400/27	770,00	800x500/33	630,00	1000x500/30	810,00
700x400/30	790,00	800x500/36	920,00	1000x500/33	830,00
700x400/33	840,00	800x500/39	940,00	1000x500/36	900,00
700x400/36	880,00	800x500/42	980,00	1000x500/39	920,00
700x400/42	960,00	800x500/45	1 040,00	1000x500/42	950,00
700x400/45	1 020,00	800x500/51	1 090,00	1000x500/45	1 020,00
700x400/51	1 100,00	800x500/54	1 160,00	1000x500/51	1 110,00
700x400/60	1 220,00	800x500/60	1 350,00	1000x500/54	1 170,00
700x400/66	1 300,00	800x500/66	1 390,00	1000x500/60	1 370,00
800x500/9	500,00	1000x500/6	540,00	1000x500/66	1 420,00
800x500/12	560,00	1000x500/9	550,00		
800x500/15	580,00	1000x500/12	580,00		

Regulatory i czujki temp. do nagrzewnic				
EKR 6.1	EKR 15.1	EKR 15.1P	TJK-10K	TR5K
Cena [EUR/szt.]				
110,00	310,00	390,00	30,00	30,00

Ceny przeliczone na PLN w dniu sprzedaży wg kursów średnich NBP.

Wentylator kanałowy • Duct fan

CFD



Typ • Type	Napięcie / Częstotliwość • Voltage / Frequency [V / Hz]	Maksymalny przepływ powietrza • Max airflow [m ³ /h]	Maksymalne ciśnienie powietrza • Max air pressure [Pa]	Cena [PLN/szt.] • Price [PLN/pc]
CFD 100	220~240 / 50	198	156	141,00
CFD 125	220~240 / 50	284	159	145,00
CFD 150/160	220~240 / 50	530	300	240,00
CFD 200	220~240 / 50	840	352	360,00
CFD 250	220~240 / 50	1405	488	593,00
CFD 315	220~240 / 50	2206	693	762,00

Wentylator kanałowy • Duct fan

CFD Silent



Typ • Type	Napięcie / Częstotliwość • Voltage / Frequency [V / Hz]	Maksymalny przepływ powietrza • Max airflow [m ³ /h]	Maksymalne ciśnienie powietrza • Max air pressure [Pa]	Cena [PLN/szt.] • Price [PLN/pc]
CFD Silent 100/125	220~240 / 50	284	159	452,00
CFD Silent 150/160	220~240 / 50	530	300	509,00
CFD Silent 200	220~240 / 50	840	352	650,00

Przełącznik biegów • Fan speed switch

HSW-01



Typ • Type	Zasilanie • Voltage [V]	Maks. natężenie prądu • Max current [A]	Cena [PLN/szt.] • Price [PLN/pc]
HSW-01	230	10	37,00



Wentylator kanałowy • Duct fan

VKAP 3.0



Praca w pomieszczeniu

Typ • Type	Cena [EUR/szt.] • Price [EUR/pc]
VKAP 100 LD 3.0	85,00
VKAP 100 MD 3.0	82,00
VKAP 125 LD 3.0	87,00
VKAP 125 MD 3.0	85,00
VKAP 150 LD 3.0	111,00
VKAP 160 LD 3.0	111,00
VKAP 160 MD 3.0	87,00

Typ • Type	Cena [EUR/szt.] • Price [EUR/pc]
VKAP 200 LD 3.0	139,00
VKAP 200 MD 3.0	111,00
VKAP 250 LD 3.0	146,00
VKAP 250 MD 3.0	113,00
VKAP 315 LD 3.0	176,00
VKAP 315 MD 3.0	171,00

Wentylator kanałowy izolowany akustycznie

• Acoustically insulated duct fan

AKU



Praca w pomieszczeniu

Typ • Type	Cena [EUR/szt.] • Price [EUR/pc]
AKU 125 D	230,00
AKU 125 M	220,00
AKU 160 D	270,00
AKU 160 M	230,00
AKU 200 D	310,00
AKU 200 M	310,00
AKU 250 D	570,00

Typ • Type	Cena [EUR/szt.] • Price [EUR/pc]
AKU 250 M	320,00
AKU 250 S	430,00
AKU 315 D	940,00
AKU 315 M	690,00
AKU 400 D	980,00
AKU 400 S	1 120,00

Pełna oferta wentylatorów SALDA - na zapytanie.

Ceny przeliczone na PLN w dniu sprzedaży wg kursów średnich NBP.



Wentylator kanałowy izolowany akustycznie

• Acoustically insulated duct fan

AKU EKO

EKO - silnik EC

Praca w pomieszczeniu



Typ • Type	Cena [EUR/szt.] • Price [EUR/pc]
AKU 125 EKO	290,00
AKU 160 EKO	380,00
AKU 200 EKO	440,00

Typ • Type	Cena [EUR/szt.] • Price [EUR/pc]
AKU 250 EKO	460,00
AKU 315 EKO	980,00

Wentylator kanałowy • Duct fan

VKA EKO

EKO - silnik EC

Praca w pomieszczeniu



Typ • Type	Cena [EUR/szt.] • Price [EUR/pc]
VKA 125 EKO	230,00
VKA 160 EKO	240,00
VKA 200 EKO	290,00

Typ • Type	Cena [EUR/szt.] • Price [EUR/pc]
VKA 250 EKO	300,00
VKA 315 EKO	380,00

Wentylator do kanałów prostokątnych • Rectangular duct fan

VKS

Praca w pomieszczeniu



Typ • Type	Cena [EUR/szt.] • Price [EUR/pc]
VKS 400-200-4 L1	370,00
VKS 400-200-4 L3	350,00
VKS 500-250-4 L1	410,00
VKS 500-250-4 L3	430,00
VKS 500-300-4 L1	490,00

Typ • Type	Cena [EUR/szt.] • Price [EUR/pc]
VKS 500-300-4 L3	510,00
VKS 600-300-4 L1	600,00
VKS 600-300-4 L3	570,00
VKS 600-350-4 L1	800,00
VKS 600-350-4 L3	760,00

Typ • Type	Cena [EUR/szt.] • Price [EUR/pc]
VKS 700-400-4 L3	1 190,00
VKS 800-500-4 L3	1 390,00
VKS 800-500-6 L3	1 790,00
VKS 1000-500-4 L3	1 410,00

Pełna oferta wentylatorów SALDA - na zapytanie.

Ceny przeliczane na PLN w dniu sprzedaży wg kursów średnich NBP.



Wentylator dachowy • Roof fan

VSA



Praca na zewnątrz

Typ • Type	Cena [EUR/szt.] • Price [EUR/pc]
VSA 190 L 3.0	130,00
VSA 190 S 3.0	120,00
VSA 220 M 3.0	150,00

Typ • Type	Cena [EUR/szt.] • Price [EUR/pc]
VSA 220 S 3.0	140,00
VSA 225 L 3.0	200,00
VSA 250 L 3.0	200,00

Wentylator dachowy • Roof fan

VSA EKO



EKO - silnik EC

Praca na zewnątrz

Typ • Type	Cena [EUR/szt.] • Price [EUR/pc]
VSA 190 EKO	300,00
VSA 220 EKO	380,00

Typ • Type	Cena [EUR/szt.] • Price [EUR/pc]
VSA 225 EKO	460,00
VSA 250 EKO	710,00

Wentylator dachowy • Roof fan

VSV



Praca na zewnątrz

Typ • Type	Cena [EUR/szt.] • Price [EUR/pc]
VSV 250-2SL1	320,00
VSV 311-4 L1	460,00
VSV 311-4 L3	480,00
VSV 355-4 L1	550,00
VSV 355-4 L3	540,00
VSV 400-4 L1	660,00
VSV 400-4 L3	690,00

Typ • Type	Cena [EUR/szt.] • Price [EUR/pc]
VSV 450-4 L1	800,00
VSV 450-4 L3	780,00
VSV 500-4 L3	1 140,00
VSV 560-4 L3	1 440,00
VSV 630-4 L3	2 190,00
VSV 630-6 L3	2 560,00

Pełna oferta wentylatorów SALDA - na zapytanie.

Ceny przeliczone na PLN w dniu sprzedaży wg kursów średnich NBP.



Wentylator dachowy • Roof fan

VSV EKO

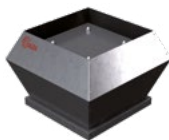

EKO - silnik EC
Praca na zewnątrz

Typ • Type	Cena [EUR/szt.] • Price [EUR/pc]
VSV 311-L1 EKO AL	1 100,00
VSV 355-L1 EKO AL	1 210,00
VSV 400-L1 EKO AL	1 710,00
VSV 450-L3 EKO AL	1 920,00

Typ • Type	Cena [EUR/szt.] • Price [EUR/pc]
VSV 500-L3 EKO AL	2 100,00
VSV 560-L3 EKO AL	2 510,00
VSV 630-L3 EKO AL	2 730,00

Wentylator kuchenny • Kitchen fan

KUB T120



< 120°C
Praca w pomieszczeniu
Praca na zewnątrz

Typ • Type	Cena [EUR/szt.] • Price [EUR/pc]
KUB 355-4L3 T120	1 010,00
KUB 400-4L3 T120	1 190,00
KUB 450-4L3 T120	1 370,00

Typ • Type	Cena [EUR/szt.] • Price [EUR/pc]
KUB 500-4L3 T120	1 370,00
KUB 560-4L3 T120	1 760,00
KUB 630-4L3 T120	2 010,00

Wentylator izolowane akustycznie • Acoustically insulated fan

KUB EKO



Praca w pomieszczeniu
Praca na zewnątrz

Typ • Type	Cena [EUR/szt.] • Price [EUR/pc]
KUB 50-355 EKO	1 160,00
KUB 67-400 EKO	1 550,00
KUB 67-500 EKO	1 710,00

Typ • Type	Cena [EUR/szt.] • Price [EUR/pc]
KUB 80-560 EKO	2 210,00
KUB 80-630 EKO	2 460,00
KUB 100-630 EKO	2 730,00

Pełna oferta wentylatorów SALDA - na zapytanie.

Ceny przeliczone na PLN w dniu sprzedaży wg kursów średnich NBP.



Wentylator kuchenny • Kitchen fan

KF T120 / KF T120 EC

< 120°C

Praca w pomieszczeniu

Praca na zewnątrz



KF T120



KF T120 EC

Typ • Type	Cena [EUR/szt.] • Price [EUR/pc]
KF-T120-160-4 L3	640,00
KF-T120-180-4 L3	710,00
KF-T120-200-4L3	720,00
KF-T120-225-4L3	730,00
KF-T120-250-4L3	820,00
KF-T120-280-4L3	1 070,00
KF-T120-315-4 L3	910,00
KF-T120-355-4 L3	1 030,00
KF-T120-400-4 L3	1 050,00

Typ • Type	Cena [EUR/szt.] • Price [EUR/pc]
KF-T120 F 160 EC	940,00
KF-T120 F 180 EC	1 140,00
KF-T120 F 200 EC	1 300,00
KF-T120 F 250 EC	1 410,00
KF-T120 F 280 EC	2 460,00
KF-T120 B 315 EC	1 480,00
KF-T120 B 355 EC	1 320,00
KF-T120 B 400 EC	1 640,00

Pełna oferta wentylatorów SALDA - na zapytanie.

Ceny przeliczane na PLN w dniu sprzedaży wg kursów średnich NBP.



Wentylator kanałowy • Duct fan

TD



Typ	Cena[PLN/szt.]
TD-250/100	569,00
TD-250/100 T	655,00
TD-350/125	583,00
TD-350/125 T	671,00
TD-500/150 3V	688,00
TD-500/150 T 3V	776,00
TD-500/160 3V	688,00
TD-500/160 T 3V	776,00
TD-800/200 3V	875,00

Typ	Cena[PLN/szt.]
TD-800/200 T 3V	1 128,00
TD-800/200N 3V	875,00
TD-1000/250 3V	1 649,00
TD-1300/250 3V	1 716,00
TD-2000/315 3V	1 837,00
TD-4000/355	3 581,00
TD-4000/355 TRIF	3 696,00
TD-6000/400	5 005,00
TD-6000/400 TRIF	4 675,00

Wentylator kanałowy • Duct fan

TD SILENT



Typ	Cena[PLN/szt.]
TD-160/100 N "T" SILENT	484,00
TD-160/100N SILENT	391,00
TD-250/100 SILENT	704,00
TD-250/100 SILENT T	777,00
TD-350/125 SILENT	715,00
TD-350/125 SILENT T	796,00

Typ	Cena[PLN/szt.]
TD-500/150-160 SILENT 3V	855,00
TD-800/200 SILENT 3V	1 084,00
TD-1000/200 SILENT 3V	1 474,00
TD-1300/250 SILENT 3V	4 022,00
TD-2000/315 SILENT 3V	4 783,00



Wentylator kanałowy • Duct fan

VENT



Typ	Cena[PLN/szt.]
VENT 100 NK	451,00
VENT 150 NK	548,00
VENT 160 NK	548,00
VENT 200 NK	745,00
VENT 250 NK	777,00
VENT 315 NK	888,00
VENT-100 ECOWATT	1 177,00
VENT-125 ECOWATT	1 188,00
VENT-125 NK	470,00
VENT-150 ECOWATT	1 760,00
VENT-160 ECOWATT	1 936,00
VENT-200 ECOWATT	2 519,00
VENT-250 ECOWATT	2 585,00
VENT-315 ECOWATT	2 640,00

Typ	Cena[PLN/szt.]
VENT-355 ECOWATT	5 665,00
VENT-355 N	3 289,00
VENT-355 NT N8	3 355,00
VENT-400 ECOWATT	5 775,00
VENT-400 N	4 147,00
VENT-400 NT C N8	3 828,00
VENT-V 100 N	669,00
VENT-V 125 N	700,00
VENT-V 150 N	800,00
VENT-V 160 N	816,00
VENT-V 200 N	946,00
VENT-V 250 N	1 221,00
VENT-V 315 N	1 584,00



Wentylator osiowy - Axial-flow fan

HCFB / HCFT



Typ	Cena[PLN/szt.]
HCFB/4-250/HA 230V	1 535,00
HCFB/4-315/HA 230V	1 584,00
HCFB/4-355/HA 230V	1 970,00
HCFB/4-400/HA 230V	2 115,00
HCFB/4-450/HA 230V	2 800,00
HCFB/4-500/HA 230V	3 080,00
HCFB/4-560/HA 230V	4 264,00
HCFB/4-630/HA 230V	4 477,00
HCFB/6-315/HA 230V	1 958,00
HCFB/6-355/HA 230V	2 334,00
HCFB/6-400/HA 230V	2 420,00
HCFB/6-450/HA 230V	2 973,00
HCFB/6-500/HA 230V	3 142,00
HCFB/6-560/HA 230V	3 465,00
HCFB/6-630/HA 230V	3 850,00
HCFB/6-710/HA 230V	4 862,00
HCFB/8-500/HA 230V	3 041,00
HCFB/8-560/HA 230V	3 487,00
HCFB/8-630/HA 230V	3 850,00
HCFT/2-250/HA 230/400V	1 639,00
HCFT/4-1000/HA 400V	12 111,00
HCFT/4-1000/L-X 230/400V	9 339,00
HCFT/4-250/HA 230/400V	1 430,00

Typ	Cena[PLN/szt.]
HCFT/4-315/HA 230/400V	1 504,00
HCFT/4-355/HA 230/400V	1 849,00
HCFT/4-400/HA 230/400V	1 925,00
HCFT/4-450/HA 230/400V	2 688,00
HCFT/4-500/HA 230/400V	2 911,00
HCFT/4-560/HA 230/400V	4 210,00
HCFT/4-630/HA 230/400V	4 670,00
HCFT/4-710/HA 230/400V	5 489,00
HCFT/4-800 HA 230/400V	8 595,00
HCFT/4-800 LA - X 230/400V	7 095,00
HCFT/6-1000/HA 230/400V	8 965,00
HCFT/6-1000/LA-X 400V	8 261,00
HCFT/6-355/HA 230/400V	2 156,00
HCFT/6-400/HA 230/400V	2 266,00
HCFT/6-450/HA 230/400V	2 516,00
HCFT/6-500/HA 230/400V	2 618,00
HCFT/6-560/HA 230/400V	3 399,00
HCFT/6-630/HA 230/400V	3 784,00
HCFT/6-710/HA 400V	4 752,00
HCFT/6-800 HA 400V	8 195,00
HCFT/6-800 L-X 230/400V	7 920,00
HCFT/8-710/HA 400V	5 225,00
HCFT/8-800/HA 230/400V	7 194,00



Nagrzewnica • Air heater

DH



Typ	Cena[PLN/szt.]
DH100/03 S 230V,50HZ	429,00
DH125/09 S 230V,50HZ	540,00
DH160/15 S 230V,50Hz	604,00
DH160/20 S 230V,50HZ	655,00
DH200/05 S 230V,50HZ	534,00
DH200/10 S 230V,50HZ	583,00
DH200/20 S 230V,50HZ	671,00
DH200/30 S 230V,50HZ	800,00
DH200/45 T 400V,50Hz	725,00

Typ	Cena[PLN/szt.]
DH200/60 T 400V,50Hz	754,00
DH250/30 T 400V,50Hz	781,00
DH250/45 T 400V,50Hz	803,00
DH250/60 T 400V,50Hz	836,00
DH250/90 T 400V,50Hz	979,00
DH315/120 T 400V,50Hz	1 045,00
DH315/60 T 400V,50Hz	891,00
DH315/90 T 400V,50Hz	1 045,00
DH400/150 T 400V,50Hz	1 368,00

Wentylator dachowy • Roof fan

RF



Typ	Cena[PLN/szt.]
RF/2-125S 230V, 50HZ	689,00
RF/2-160S 230V, 50HZ	770,00
RF/2-200S 230V, 50HZ	1 331,00
RF/4-125S 230V, 50HZ	798,00
RF/4-160S 230V, 50Hz	869,00
RF/4-200S 230V, 50HZ	1 155,00
RF/4-250S 230V, 50HZ	2 002,00
RF/4-315T 400V, 50HZ	2 376,00
RF/4-355T 400V, 50Hz	3 135,00
RF/4-400T 400V, 50Hz	4 345,00
RF/4-450T/H 400V, 50Hz	4 279,00

Typ	Cena[PLN/szt.]
RF/4-500T 400V, 50Hz	6 600,00
RF/4-560T/H 400V, 50Hz	6 655,00
RF/6-250S 230V, 50HZ	2 310,00
RF/6-315S 230V, 50HZ	2 376,00
RF/6-355T 400V, 50Hz	3 245,00
RF/6-400T 400V, 50Hz	3 355,00
RF/6-450T 400V, 50Hz	4 235,00
RF/6-500T 400V, 50Hz	4 576,00
RF/6-560T 400V, 50Hz	7 645,00
RF/6-630T 400V, 50Hz	10 010,00



Wentylator dachowy • Roof fan

TH



Typ	Cena[PLN/szt.]
TH-1300 3V 230V	3 790,00
TH-2000 3V 230V	4 315,00
TH-500/150 3V 230V	1 815,00

Typ	Cena[PLN/szt.]
TH-500/160 3V 230V	1 958,00
TH-800 3V 230V	2 300,00
TH-800 N 3V 230V	2 400,00

Wentylator dachowy • Roof fan

RFV



Typ	Cena[PLN/szt.]
RFV/2-125S 230V, 50HZ	809,00
RFV/2-160S/H 230V, 50HZ	1 001,00
RFV/2-160S/L 230V, 50HZ	822,00
RFV/2-200S 230V, 50HZ	1 375,00
RFV/4-125S 230V, 50HZ	979,00
RFV/4-160S 230V, 50HZ	1 067,00
RFV/4-200S 230V, 50HZ	1 155,00

Typ	Cena[PLN/szt.]
RFV/4-250S 230V, 50HZ	1 936,00
RFV/4-250T 400V, 50HZ	2 420,00
RFV/4-315S 230V, 50HZ	2 211,00
RFV/4-315T 400V, 50HZ	2 321,00
RFV/4-355S 230V, 50HZ	3 102,00
RFV/4-355T 400V, 50HZ	2 728,00
RFV/4-400S 230V, 50HZ	3 399,00

Wentylator łazienkowy i kuchenny • Fan for bathroom and kitchen

SILENT



Typ	Cena[PLN/szt.]
SILENT 100 CDZ	635,00
SILENT 100 CHZ	583,00
SILENT 100 CRIZ	446,00
SILENT 100 CRIZ SILVER	508,00
SILENT 100 CRZ	380,00
SILENT 100 CRZ SILVER	473,00
SILENT 100 CZ - 12V	308,00
SILENT 100 CZ	259,00
SILENT 100 CZ SILVER	352,00

Typ	Cena[PLN/szt.]
SILENT 200 CHZ	615,00
SILENT 200 CRZ	396,00
SILENT 200 CRZ SILVER	501,00
SILENT 200 CZ	341,00
SILENT 200 CZ SILVER	451,00
SILENT 300 CHZ	759,00
SILENT 300 CHZ SILVER	833,00
SILENT 300 CRZ	679,00
SILENT 300 CRZ SILVER	748,00



Wentylator łazienkowy i kuchenny • Fan for bathroom and kitchen

DECOR



Typ	Cena[PLN/szt.]
DECOR 100C - 12V	288,00
DECOR 100CDZ	627,00
DECOR 100CHZ	627,00
DECOR 100CRZ	352,00
DECOR 100CZ	248,00
DECOR 200CHZ	695,00
DECOR 200CRZ	385,00

Typ	Cena[PLN/szt.]
DECOR 200CZ	285,00
DECOR 300CHZ	748,00
DECOR 300CRZ	667,00
DECOR 300CZ	449,00
DECOR 300HZ	638,00
DECOR 300RZ	479,00
DECOR 300SZ	319,00

Wentylator łazienkowy i kuchenny • Fan for bathroom and kitchen

EDM



Typ	Cena[PLN/szt.]
EDM 100CHZ	550,00
EDM 100CRZ	374,00
EDM 100CTZ	352,00
EDM 100CZ	294,00
EDM 100ECZ	399,00
EDM 100MZ	334,00
EDM 100RZ	308,00

Typ	Cena[PLN/szt.]
EDM 100S - 12V	264,00
EDM 100SZ	200,00
EDM 100TZ	303,00
EDM 100VMZ	418,00
EDM 200CHZ	693,00
EDM 200CRZ	435,00
EDM 200CZ	352,00

Wentylator łazienkowy i kuchenny • Fan for bathroom and kitchen

SILENT DESIGN



Typ	Cena[PLN/szt.]
SILENT DESIGN	
100 CHZ - 3C	623,00
100 CMZ - 3C	374,00
100 CRZ - 3C	425,00
100 CRZ	391,00
100 CZ - 3C	296,00
200 CHZ - 3C	638,00
200 CRZ - 3C	418,00
200 CZ - 3C	369,00
300 CHZ - 3C	792,00

Typ	Cena[PLN/szt.]
SILENT SILVER DESIGN	
100 CHZ	649,00
100 CRZ	455,00
100 CZ	337,00
200 CHZ - 3C	737,00
200 CZ - 3C	462,00
300 CHZ - 3C	836,00

Pełna oferta wentylatorów
Venture Industries
- na zapytanie.

Wentylator dachowy standardowy • *Standard roof fan*

DAs



Typ • <i>Type</i>	Napięcie 3 x 400 V	Napięcie 1 x 230 V	2-biegowe napięcie 3 x 400 V	3-biegowe napięcie 3 x 400 V
	Cena [PLN/szt.] • <i>Price [PLN/pc]</i>			
DAs-160	3 280,00	3 380,00	x	x
DAs-200	3 545,00	3 660,00	4 090,00	4 895,00
DAs-250	4 490,00	4 590,00	4 835,00	5 145,00
DAs-315	5 505,00	5 605,00	5 795,00	5 925,00
DAs-400	11 585,00	x	x	x
DAs-500	19 195,00	x	x	x
DAs-630	28 200,00	x	x	x

Wentylator dachowy kwasoodporny • *Acid-resistant roof fan*

DAk



Typ • <i>Type</i>	Napięcie 3 x 400 V	Napięcie 1 x 230 V	2-biegowe napięcie 3 x 400 V	3-biegowe napięcie 3 x 400 V
	Cena [PLN/szt.] • <i>Price [PLN/pc]</i>			
DAk-160	3 705,00	3 805,00	x	x
DAk-200	4 280,00	4 380,00	5 080,00	5 775,00
DAk-250	5 145,00	5 245,00	5 685,00	5 995,00
DAk-315	6 430,00	6 530,00	6 765,00	7 115,00
DAk-400	12 860,00	x	x	x
DAk-630	28 200,00	x	x	x

Wentylator dachowy przeciwybuchowy • *Anti-explosive roof fan*

DAEx



Typ • <i>Type</i>	3 x 400 V / gazy klasa T3	3 x 400 V / pyły	3 x 400 V / gazy klasa T4
	Cena [PLN/szt.] • <i>Price [PLN/pc]</i>		
DAExC-160	4 680,00	4 680,00	5 150,00
DAExC-200	5 350,00	5 350,00	5 885,00
DAExC-250	7 570,00	7 570,00	8 330,00
DAExC-315	8 840,00	8 840,00	9 725,00
DAExC-400	16 620,00	16 620,00	18 285,00
DAExC-630	38 600,00	38 600,00	42 460,00

Wentylator dachowy cichobieżny • *Roof fan*

SILWENT



Typ • <i>Type</i>	Napięcie 3 x 400 V	Napięcie 1 x 230 V	Dwubiegowe Napięcie 3 x 400 V
	Cena [PLN/szt.] • <i>Price [PLN/pc]</i>		
SILWENT-160/MW	3 865,00	3 865,00	x
SILWENT-315	6 670,00	x	6 670,00

Wentylator dachowy izolowany akustycznie • *Acoustic roof fan*

SZTIL



Typ • <i>Type</i>	Napięcie 3 x 400 V	Napięcie 1 x 230 V
	Cena [PLN/szt.] • <i>Price [PLN/pc]</i>	
SZTIL-160/W2	3 095,00	3 195,00
SZTIL-200/W2	3 520,00	3 620,00
SZTIL-250/W2	4 005,00	4 105,00
SZTIL-315	4 650,00	4 750,00
SZTIL-400/MW	14 215,00	14 315,00
SZTIL-500	17 530,00	x

WENTYLATORY

Wentylatory i wywiewniki Uniwersal • *Universal fans and graviation fans*



Wentylator dachowy • *Roof fan*

FEN



Typ • <i>Type</i>	Napięcie 3 x 400V	Napięcie 1 x 230V
	Cena [PLN/szt.] • <i>Price [PLN/pc]</i>	
FEN-160	2 800,00	2 900,00
FEN-250	3 995,00	4 095,00
FEN-315	5 080,00	5 180,00
FEN-400	12 425,00	×
FEN-500	12 740,00	×

Wywiewnik • *Graviation fan*

WLO



Typ • <i>Type</i>	Cena [PLN/szt.] • <i>Price [PLN/pc]</i>
WLO-160	560,00
WLO-200	1 380,00
WLO-250	1 400,00
WLO-315	1 780,00
WLO-400	2 720,00
WLO-630	6 770,00

Wywiewnik • *Graviation fan*

ZEFIR



Typ • <i>Type</i>	Laminat z PŁYTĄ MONTAŻOWĄ • <i>Laminat</i>	Laminat NA RURĘ PVC • <i>Rustproof</i>
	Cena [PLN/szt.] • <i>Price [PLN/pc]</i>	
ZEFIR-140	380,00	430,00
ZEFIR-250	920,00	1 130,00

Wywiewiak zintegrowany • *Integrated ventilating fan*

WZ



Typ • <i>Type</i>	WZ Standardowy • <i>Laminat</i>	WZk Kwasoodporny • <i>Acid-resistant</i>	WZEx Przeciwybuchowy • <i>Anti-explosive</i>
	Cena [PLN/szt.] • <i>Price [PLN/pc]</i>		
WZ 315/160	2 165,00	5 065,00	3 200,00
WZ 400/250	3 340,00	2 165,00	4 300,00
WZ 630/315	5 065,00	3 340,00	5 760,00

Cena zawiera jedynie koszt wywiewiaka właściwego (nie zawiera ceny wentylatora, ani podstawy dachowej).
• *Price includes only the cost of the vent (excluding price of the fan and roof base).*

Wentylator osiowy

• *Axial-flow fan*

AKWILON



Typ • <i>Type</i>	Napięcie 3 x 400 V	Napięcie 1 x 230 V
	Cena [PLN/szt.] • <i>Price [PLN/pc]</i>	
500	6 845,00	6 945,00
500/DA	7 025,00	7 125,00

Wentylator kanałowy

• *Duct fan*

VENTO



Typ • <i>Type</i>	Napięcie 3 x 400 V do 40°C	Napięcie 1 x 230 V do 40°C
	Cena [PLN/szt.] • <i>Price [PLN/pc]</i>	
200	4 075,00	4 175,00

Podstawa dachowa tłumiąca

• *Insulating roof fan*



Typ • <i>Type</i>	PTL	PTS
	Cena [PLN/szt.] • <i>Price [PLN/pc]</i>	
160	2 050,00	2 115,00
200	2 450,00	2 375,00
250	2 790,00	2 640,00
315	3 855,00	3 090,00
400	6 765,00	4 700,00
500	6 765,00	7 175,00
630	×	7 350,00

Podstawa dachowa typ B/I

• *Roof fan, type B/I*

Typ • <i>Type</i>	LAMINAT	STAL • <i>STEEL</i>	LAMINAT EX
	Cena [PLN/szt.] • <i>Price [PLN/pc]</i>		
160	330,00	425,00	380,00
200	460,00	450,00	510,00
250	500,00	565,00	530,00
315	690,00	615,00	780,00
400	990,00	740,00	1 120,00
500	1 130,00	990,00	×
630	1 315,00	1 265,00	1 430,00

Pełna oferta wentylatorów Uniwersal - na zapytanie.



Wentylator do kanałów okrągłych • Fan for circular ducts

K



Typ • Type	Cena [PLN/szt.] • Price [PLN/pc]
K 100 M sileo	459,00
K 100 XL sileo	502,00
K 125 M sileo	464,00
K 125 XL sileo	509,00
K 150 M sileo	513,00
K 150 XL sileo	614,00
K 160 M sileo	518,00

Typ • Type	Cena [PLN/szt.] • Price [PLN/pc]
K 160 XL sileo	618,00
K 200 L sileo	754,00
K 200 M sileo	617,00
K 250 L sileo	790,00
K 250 M sileo	644,00
K 315 sileo	971,00

Wentylator dachowy • Roof fan

DVS



Typ • Type	Cena [PLN/szt.] • Price [PLN/pc]
DVS 190EZ sileo	1 319,00
DVS 225EZ sileo	1 297,00
DVS 310EV	2 507,00
DVS 311EV sileo	2 344,00
DVS 355DV sileo	3 292,00
DVS 355E4 sileo	3 184,00
DVS 400DS sileo	3 565,00
DVS 400DV sileo	3 434,00
DVS 400E4 sileo	3 358,00
DVS 400E6 sileo	3 478,00
DVS 450DV sileo	4 219,00
DVS 450E6 sileo	4 252,00

Typ • Type	Cena [PLN/szt.] • Price [PLN/pc]
DVS 450EV sileo	4 426,00
DVS 500DS sileo	4 721,00
DVS 500DV sileo	5 985,00
DVS 500E4 sileo	5 996,00
DVS 500E6 sileo	5 582,00
DVS 560DS sileo	6 705,00
DVS 560DV sileo	7 555,00
DVS 630DS sileo	8 035,00
DVS 630DV sileo	8 744,00
DVS 710DS	12 145,00
DVS 710DV sileo	11 382,00

Pełna oferta wentylatorów Systemair - na zapytanie.



Wentylator dachowy • Roof fan

DH / DHE



Typ • Type	Cena [EUR/szt.] • Price [EUR/pc]
DH 190-2 E	173,00
DH 225-2 E	212,00
DH 280-2 E	357,00
DH 280-4 E	397,00
DH 310L-4 D Ex	770,00
DH 355-4 D Ex	1 037,00
DH 400-4 D Ex	1 089,00
DH 450-4 D Ex	1 339,00
DH 500-4 D Ex	1 782,00
DH 560-4 D Ex	2 445,00
DH 630-6 D Ex	2 334,00
DHE 310-4 E	323,00
DHE 310-4 D	413,00
DHE 355-4 E	525,00

Typ • Type	Cena [EUR/szt.] • Price [EUR/pc]
DHE 355-4 D	503,00
DHE 400-4 E	583,00
DHE 400-4 D	580,00
DHE 450-4 E	770,00
DHE 450-4 D	675,00
DHE 450-6 D	710,00
DHE 500-4 E	880,00
DHE 500-4 D	838,00
DHE 500-6 D	798,00
DHE 560-4 D	1 190,00
DHE 560-6 D	1 043,00
DHE 630-4 D	1 618,00
DHE 630-6 D	1 313,00

Wentylator do kanałów okrągłych • Fan for circular ducts

R



Typ • Type	Cena [EUR/szt.] • Price [EUR/pc]
R 100	80,00
R 100 G	225,00
R 125	80,00
R 125 G	227,00
R 150	112,00
R 160	114,00
R 160 L	123,00
R 160 G	229,00
R 200	128,00
R 200 G	253,00

Typ • Type	Cena [EUR/szt.] • Price [EUR/pc]
R 250	126,00
R 250 L	137,00
R 250 G	267,00
R 315	179,00
R 315 M	182,00
R 315 G	396,00
R 315 L G	400,00
R 355 M	357,00
R 355 G	634,00
R 355 L G	685,00

* Konsola montażowa w standardzie.

Pełna oferta wentylatorów Rosenberg - na zapytanie.

Ceny przeliczone na PLN w dniu sprzedaży wg kursów średnich NBP.



Aparat grzewczo-wentylacyjny • Heating and ventilation unit

LEO



Typ • Type	Moc nominalna • Heating power [kW]	Cena [PLN/szt.] • Price [PLN/pc]
LEO S2 zestaw	2,1 - 26,5	1 130,00
LEO S3 zestaw	1,7 - 32,7	1 240,00
LEO L2 zestaw	2,2 - 50,4	1 520,00
LEO L3 zestaw	3,2 - 65,2	1 590,00
LEO XL2 zestaw	6,6 - 94,0	2 230,00

Pełna oferta urządzeń Flowair - na zapytanie.

Akcesoria • Accessories

SRQ2d-1/2	SRQ3d-1/2	SRQ2d-3/4	SRQ3d-3/4
zawory z silownikiem • the valve with servomotor			
Cena [PLN/szt.] • Price [PLN/pc]			
249,00	283,00	262,00	283,00



Klapa przeciwpożarowa motylkowa okrągła • Round fire damper

FBC



Klapa przeciwpożarowa motylkowa okrągła FBC

Typ • Type	Cena [EUR/szt.] • Price [EUR/pc]			
	ø100	ø125	ø160	ø200
FBC1-S0 EI60S, bez mikroprzełączników • EI60S, no microswitches	24,65	27,44	32,33	38,60
FBC1-S1 EI60S, jeden mikroprzełącznik • EI60S, one microswitch	31,40	33,95	38,84	45,12
FBC7-S0 EI120S, bez mikroprzełączników • EI120S, no microswitches	30,70	35,35	39,53	50,00
FBC7-S1 EI120S, jeden mikroprzełącznik • EI120S, one microswitch	37,21	42,09	46,05	56,74

Dodatkowo na zamówienie:

- klapy wyposażone w zawór powietrzny,
- klapy wyposażone w zawór powietrzny i mikroprzełącznik,
- klapy w odporności EI90S - we wszystkich powyższych rozmiarach i konfiguracjach.

KLAPY PRZECIWOPOŻAROWE

Klapy przeciwpożarowe okrągłe Lindab - Lindab round fire dampers



Klapa przeciwpożarowa okrągła - Round fire damper

WH



WH25



WH45

Klapa przeciwpożarowa okrągła WH25

Średnica - Diameter [mm]	Cena [PLN/szt.] - Price [PLN/pc]			
	WH25C-S0-M0	WH25C-S2-M0	WH25VSB	WH25DSB
100	279,00	346,00	1 314,00	1 387,00
125	290,00	358,00	1 326,00	1 399,00
140	293,00	361,00	1 329,00	1 402,00
150	298,00	364,00	1 332,00	1 405,00
160	308,00	375,00	1 345,00	1 418,00
180	313,00	382,00	1 351,00	1 424,00
200	325,00	395,00	1 364,00	1 437,00
224	333,00	404,00	1 372,00	1 446,00
250	350,00	422,00	1 391,00	1 464,00
280	361,00	434,00	1 402,00	1 475,00
300	369,00	442,00	1 390,00	1 463,00
315	385,00	460,00	1 428,00	1 502,00

Klapa przeciwpożarowa okrągła WH45

Średnica - Diameter [mm]	Cena [PLN/szt.] - Price [PLN/pc]			
	WH45B-S0-M0	WH45B-S2-M0	WH45VMB	WH45DMB
355	648,00	745,00	1 726,00	1 812,00
400	707,00	804,00	1 777,00	1 863,00
450	755,00	852,00	1 823,00	1 909,00
500	769,00	866,00	1 834,00	1 920,00
560	833,00	930,00	1 890,00	1 977,00
600	880,00	977,00	1 930,00	2 016,00
630	919,00	1 016,00	1 964,00	2 050,00
710	1 035,00	1 132,00	2 301,00 *	2 502,00 **
800	1 155,00	1 252,00	2 405,00 *	2 607,00 **

B - wersja Basic

C - wersja Compact

M0 - bez elektromagnesu

S0 - bez mikroprzełączników wskazujących pozycję

S2 - z dwoma mikroprzełącznikami wskazującymi pozycję

VSB - z siłownikiem Belimo BFL24T

DSB - z siłownikiem Belimo BFL230T

VMB - z siłownikiem Belimo BFN24T

* WH45VGB - z siłownikiem Belimo BF24T

DMB - z siłownikiem Belimo BFN230T

** WH45DGB - z siłownikiem Belimo BF230T



Klapa przeciwpożarowa prostokątna - Rectangular fire damper

WK25



Klapa przeciwpożarowa prostokątna WK25C-S0-M0

Szerokość • Width [mm]	Cena [PLN/szt.] • Price [PLN/pc]				
	Wysokość • Height [mm]				
	200	300	400	500	600
100	415,00	444,00	472,00	502,00	532,00
200	450,00	481,00	515,00	550,00	580,00
300	479,00	513,00	552,00	589,00	624,00
400	512,00	551,00	593,00	635,00	674,00
500	541,00	584,00	630,00	675,00	718,00
600	571,00	617,00	668,00	718,00	765,00
700	600,00	650,00	705,00	759,00	822,00
800	630,00	685,00	743,00	814,00	869,00

Klapa przeciwpożarowa prostokątna WK25C-S2-M0

Szerokość • Width [mm]	Cena [PLN/szt.] • Price [PLN/pc]				
	Wysokość • Height [mm]				
	200	300	400	500	600
100	489,00	518,00	548,00	578,00	609,00
200	525,00	557,00	592,00	628,00	660,00
300	555,00	591,00	631,00	669,00	706,00
400	590,00	630,00	673,00	717,00	758,00
500	619,00	663,00	711,00	759,00	803,00
600	650,00	698,00	750,00	802,00	851,00
700	680,00	733,00	789,00	844,00	910,00
800	712,00	768,00	828,00	902,00	959,00

C - wersja Compact
M0 - bez elektromagnesu

S0 - bez mikroprzełączników wskazujących pozycję
S2 - z dwoma mikroprzełącznikami wskazującymi pozycję



Klapa przeciwpożarowa prostokątna - Rectangular fire damper

WK25



Klapa przeciwpożarowa prostokątna WK25VSB

Szerokość • Width [mm]	Cena [PLN/szt.] • Price [PLN/pc]				
	Wysokość • Height [mm]				
	200	300	400	500	600
100	1 382,00	1 410,00	1 437,00	1 467,00	1 496,00
200	1 416,00	1 447,00	1 480,00	1 514,00	1 545,00
300	1 445,00	1 479,00	1 517,00	1 554,00	1 589,00
400	1 478,00	1 516,00	1 558,00	1 600,00	1 638,00
500	1 506,00	1 548,00	1 594,00	1 640,00	1 682,00
600	1 536,00	1 582,00	1 632,00	1 682,00	1 728,00
700	1 565,00	1 615,00	1 669,00	1 722,00	1 785,00
800	1 594,00	1 649,00	1 706,00	1 777,00	1 832,00

Klapa przeciwpożarowa prostokątna WK25DSB

Szerokość • Width [mm]	Cena [PLN/szt.] • Price [PLN/pc]				
	Wysokość • Height [mm]				
	200	300	400	500	600
100	1 459,00	1 487,00	1 514,00	1 543,00	1 573,00
200	1 493,00	1 523,00	1 557,00	1 591,00	1 621,00
300	1 521,00	1 555,00	1 594,00	1 631,00	1 666,00
400	1 554,00	1 593,00	1 634,00	1 676,00	1 714,00
500	1 582,00	1 625,00	1 671,00	1 716,00	1 759,00
600	1 612,00	1 659,00	1 709,00	1 758,00	1 805,00
700	1 641,00	1 692,00	1 745,00	1 799,00	1 862,00
800	1 671,00	1 725,00	1 783,00	1 854,00	1 909,00

VSB - z silownikiem Belimo BFL24T

DSB - z silownikiem Belimo BFL230T



Klapa przeciwpożarowa prostokątna - Rectangular fire damper

WK45



Klapa przeciwpożarowa prostokątna WK45B-S0-M0

Szerokość • Width [mm]	Cena [PLN/szt.] • Price [PLN/pc]						
	Wysokość • Height [mm]						
	200	300	400	500	600	700	800
200	494,00	528,00	558,00	600,00	638,00	×	×
300	531,00	568,00	605,00	650,00	693,00	740,00	×
400	572,00	614,00	655,00	706,00	753,00	804,00	851,00
500	609,00	656,00	701,00	757,00	809,00	865,00	929,00
600	647,00	698,00	748,00	810,00	866,00	941,00	996,00
700	684,00	740,00	795,00	860,00	935,00	1 001,00	1 061,00
800	712,00	772,00	847,00	931,00	998,00	1 069,00	1 133,00
900	748,00	814,00	906,00	981,00	1 053,00	1 129,00	1 199,00
1000	788,00	871,00	956,00	1 035,00	1 112,00	1 192,00	1 266,00
1100	839,00	915,00	1 004,00	1 088,00	1 169,00	1 255,00	1 334,00
1200	876,00	956,00	1 050,00	1 139,00	1 226,00	1 315,00	1 399,00
1300	913,00	997,00	1 096,00	1 190,00	1 281,00	1 375,00	1 464,00
1400	954,00	1 044,00	1 148,00	1 246,00	1 342,00	1 442,00	1 534,00
1500	991,00	1 085,00	1 193,00	1 297,00	1 398,00	1 502,00	1 600,00

B - wersja Basic

M0 - bez elektromagnesu

S0 - bez mikroprzełączników wskazujących pozycję



Klapa przeciwpożarowa prostokątna - Rectangular fire damper

WK45



Klapa przeciwpożarowa prostokątna WK45B-SA-M0

Szerokość • Width [mm]	Cena [PLN/szt.] • Price [PLN/pc]						
	Wysokość • Height [mm]						
	200	300	400	500	600	700	800
200	541,00	575,00	606,00	647,00	686,00	×	×
300	579,00	616,00	653,00	698,00	742,00	788,00	×
400	620,00	662,00	704,00	754,00	802,00	854,00	900,00
500	657,00	704,00	749,00	805,00	858,00	915,00	979,00
600	695,00	747,00	797,00	858,00	916,00	991,00	1 047,00
700	732,00	789,00	844,00	909,00	985,00	1 051,00	1 112,00
800	761,00	821,00	897,00	981,00	1 049,00	1 120,00	1 185,00
900	797,00	863,00	956,00	1 032,00	1 104,00	1 180,00	1 250,00
1000	837,00	921,00	1 006,00	1 086,00	1 163,00	1 244,00	1 319,00
1100	889,00	965,00	1 055,00	1 139,00	1 221,00	1 307,00	1 387,00
1200	925,00	1 006,00	1 101,00	1 191,00	1 278,00	1 368,00	1 452,00
1300	962,00	1 048,00	1 148,00	1 242,00	1 334,00	1 428,00	1 518,00
1400	1 004,00	1 095,00	1 200,00	1 298,00	1 395,00	1 495,00	1 589,00
1500	1 042,00	1 136,00	1 245,00	1 350,00	1 451,00	1 556,00	1 654,00

B - manualna
M0 - bez elektromagnesu

SA - z mikroprzełącznikiem otwartej klapki



Klapa przeciwpożarowa prostokątna - Rectangular fire damper

WK45



Klapa przeciwpożarowa prostokątna WK45VMB

Szerokość • Width [mm]	Cena [PLN/szt.] • Price [PLN/pc]						
	Wysokość • Height [mm]						
	200	300	400	500	600	700	800
200	1 635,00	1 667,00	1 707,00	1 747,00	1 784,00	×	×
300	1 671,00	1 707,00	1 752,00	1 797,00	1 838,00	1 883,00	×
400	1 711,00	1 752,00	1 802,00	1 851,00	1 897,00	1 947,00	1 992,00
500	1 747,00	1 791,00	1 846,00	1 901,00	1 952,00	2 007,00	2 069,00
600	1 783,00	1 834,00	1 892,00	1 952,00	2 008,00	2 080,00	2 135,00
700	1 818,00	1 874,00	1 937,00	2 001,00	2 075,00	2 140,00	2 199,00
800	1 856,00	1 915,00	1 984,00	2 066,00	2 131,00	2 201,00	2 265,00
900	1 891,00	1 956,00	2 042,00	2 116,00	2 186,00	2 259,00	2 328,00
1000	1 930,00	2 012,00	2 090,00	2 169,00	2 244,00	2 323,00	2 654,00 *
1100	1 980,00	2 053,00	2 137,00	2 220,00	2 300,00	2 384,00	2 720,00 *
1200	2 015,00	2 094,00	2 181,00	2 270,00	2 354,00	2 701,00 *	2 784,00 *
1300	2 050,00	2 135,00	2 227,00	2 320,00	2 409,00	2 761,00 *	2 848,00 *
1400	2 092,00	2 180,00	2 277,00	2 375,00	2 727,00 *	2 825,00 *	2 918,00 *
1500	2 127,00	2 220,00	2 322,00	2 425,00	2 781,00 *	2 884,00 *	2 981,00 *

VMB - z silownikiem Belimo BFN24T

* WK45VGB - z silownikiem Belimo BF24T



Klapa przeciwpożarowa prostokątna - Rectangular fire damper

WK45



Klapa przeciwpożarowa prostokątna WK45DMB

Szerokość • Width [mm]	Cena [PLN/szt.] • Price [PLN/pc]						
	Wysokość • Height [mm]						
	200	300	400	500	600	700	800
200	1 721,00	1 752,00	1 792,00	1 833,00	1 869,00	×	×
300	1 756,00	1 792,00	1 837,00	1 882,00	1 923,00	1 969,00	×
400	1 797,00	1 837,00	1 887,00	1 937,00	1 983,00	2 033,00	2 077,00
500	1 832,00	1 878,00	1 932,00	1 986,00	2 037,00	2 092,00	2 154,00
600	1 868,00	1 919,00	1 978,00	2 037,00	2 093,00	2 166,00	2 221,00
700	1 905,00	1 959,00	2 023,00	2 087,00	2 161,00	2 225,00	2 284,00
800	1 941,00	2 000,00	2 069,00	2 151,00	2 217,00	2 286,00	2 350,00
900	1 976,00	2 041,00	2 127,00	2 201,00	2 272,00	2 346,00	2 413,00
1000	2 015,00	2 097,00	2 175,00	2 254,00	2 329,00	2 408,00	2 844,00 *
1100	2 065,00	2 140,00	2 223,00	2 306,00	2 385,00	2 469,00	2 909,00 *
1200	2 101,00	2 179,00	2 268,00	2 355,00	2 440,00	2 891,00 *	2 973,00 *
1300	2 137,00	2 220,00	2 312,00	2 405,00	2 494,00	2 950,00 *	3 037,00 *
1400	2 177,00	2 266,00	2 362,00	2 460,00	2 917,00 *	3 014,00 *	3 107,00 *
1500	2 213,00	2 305,00	2 408,00	2 510,00	2 972,00 *	3 074,00 *	3 170,00 *

DMB - z silownikiem Belimo BFN230T

* WK45DGB - z silownikiem Belimo BF230T



Kłapa przeciwpożarowa okrągła, napęd sprężynowy

• Round fire damper, mainspring powered

KTS-O-S



Średnica [mm] • Diameter [mm]	160	200	250	315	355	400	450	500	630
Cena [PLN/szt.] • Price [PLN/pc]	581,91	629,27	696,78	795,38	855,23	896,60	986,79	1 042,55	1 251,08

Kłapa przeciwpożarowa, napęd sprężynowy

• Fire damper, mainspring powered

KTM-M



Średnica • Diameter [mm]	100	125	160	200	250
Cena [PLN/szt.] • Price [PLN/pc]	270,71	286,21	329,46	364,63	399,31

Opcja • Option:

dopłata dla krańcówki w położeniu "zamknięta" • extra charge for a limit switch in the „close” position: **+ 95,00 PLN**

dopłata dla krańcówki w położeniu "otwarta" • extra charge for a limit switch in the „open” position: **+ 95,00 PLN**

KLAPY PRZECIWPÓŻAROWE

Klapy przeciwpożarowe okrągłe Mercor • Mercor round fire dampers



Klapa przeciwpożarowa • Fire damper EIS 120		MCR FID PRO						
Typ • Type	Cena [PLN/szt.] • Price [PLN/pc]							
	Średnica • Diameter [mm]							
	100	125	150	160	200	250	300	315
RST SPRĘŻYNA Z TOPIKIEM • MAINSPRING POWERED	na zapytanie							
RST + WK1 SPRĘŻYNA Z TOPIKIEM + 1 KRAŃCÓWKA • MAINSPRING POWERED + ONE MICROSWITCH								
RST + WK2 SPRĘŻYNA Z TOPIKIEM + 2 KRAŃCÓWKI • MAINSPRING POWERED + TWO MICROSWITCHES								
BELIMO 24T SIŁOWNIK • ACTUATOR								
BELIMO 230T SIŁOWNIK • ACTUATOR								



Siłownik do przepustnic bez sprężyny powrotnej • Actuator for dampers without return spring



2 Nm	Cena [PLN/szt.] • Price [PLN/pc]
DA02N24	300,00
DA02N220	348,00
DA02N24S	321,00
DA02N220S	371,00
DA02N24PI	359,00
DA02N220PI	428,00
DA02N24PIS	380,00
DA02N220PIS	445,00

4 Nm	Cena [PLN/szt.] • Price [PLN/pc]
DA04N24	399,00
DA04N220	473,00
DA04N24S	428,00
DA04N220S	500,00
DA04N24PI	492,00
DA04N220PI	492,00
DA04N24PIS	492,00
DA04N220PIS	565,00



8 Nm	Cena [PLN/szt.] • Price [PLN/pc]
DA08N24	522,00
DA08N220	538,00
DA08N24S	582,00
DA08N220S	597,00
DA08N24PI	610,00
DA08N220PI	671,00
DA08N24PIS	691,00
DA08N220PIS	798,00

16 Nm	Cena [PLN/szt.] • Price [PLN/pc]
DA16N24	626,00
DA16N220	645,00
DA16N24S	699,00
DA16N220S	716,00
DA16N24PI	732,00
DA16N220PI	805,00
DA16N24PIS	830,00
DA16N220PIS	958,00

Siłownik do przepustnic bez sprężyny powrotnej • Actuator for dampers without return spring

24 Nm	Cena [PLN/szt.] • Price [PLN/pc]
DA24N24	751,00
DA24N220	774,00
DA24N24S	838,00
DA24N220S	859,00
DA24N24PI	878,00
DA24N220PI	967,00
DA24N24PIS	996,00
DA24N220PIS	1 149,00

32 Nm	Cena [PLN/szt.] • Price [PLN/pc]
DA32N24	818,00
DA32N220	843,00
DA32N24S	915,00
DA32N220S	970,00
DA32N24PI	989,00
DA32N220PI	1 024,00
DA32N24PIS	1 145,00
DA32N220PIS	1 075,00

Siłownik do przepustnic bez sprężyny powrotnej z przyspieszonym biegiem

• Fast running non spring return actuator for dampers



8 Nm	Cena [PLN/szt.] • Price [PLN/pc]
DA08F24	541,00
DA08F220	592,00
DA08F24S	592,00
DA08F220S	663,00
DA08F24PI	756,00
DA08F220PI	na zapytanie
DA08F24PIS	859,00
DA08F220PIS	na zapytanie

16 Nm	Cena [PLN/szt.] • Price [PLN/pc]
DA16F24	696,00
DA16F220	777,00
DA16F24S	715,00
DA16F220S	802,00
DA16F24PI	895,00
DA16F220PI	na zapytanie
DA16F24PIS	959,00
DA16F220PIS	na zapytanie



Siłownik do przepustnic ze sprężyną powrotną • Spring return actuator for dampers



3 Nm	Cena [PLN/szt.] • Price [PLN/pc]
DA03S24	581,00
DA03S220	582,00
DA03S24S	582,00
DA03S220S	589,00
DA03S24P	662,00
DA03S24PS	843,00

5 Nm	Cena [PLN/szt.] • Price [PLN/pc]
DA05S24	758,00
DA05S220	771,00
DA05S24S	771,00
DA05S220S	795,00
DA05S24P	982,00
DA05S24PS	1 009,00



10 Nm	Cena [PLN/szt.] • Price [PLN/pc]
DA10S24	896,00
DA10S220	928,00
DA10S24S	928,00
DA10S220S	953,00
DA10S24P	1 231,00
DA10S24PS	1 290,00

15 Nm	Cena [PLN/szt.] • Price [PLN/pc]
DA15S24	1 074,00
DA15S220	1 207,00
DA15S24S	1 251,00
DA15S220S	1 378,00
DA15S24P	1 305,00
DA15S24PS	1 353,00



Siłownik do przepustnic bez sprężyny powrotnej • Actuator for dampers without return spring



LM 5 Nm	Cena [PLN/szt.] • Price [PLN/pc]
LM230A	585,00
LM230A-F	585,00
LM230A-S	661,00
LM230ASR	938,00
LM24A	585,00
LM24A-F	585,00
LM24A-MOD	1 101,00
LM24A-MP	873,00
LM24A-S	661,00
LM24A-SR	786,00
LM24A-SR-F	786,00

NM 10 Nm	Cena [PLN/szt.] • Price [PLN/pc]
NM230A	737,00
NM230A-F	737,00
NM230A-S	879,00
NM230ASR	1 177,00
NM24A	713,00
NM24A-F	713,00
NM24A-MP	1 125,00
NM24AP5	1 001,00
NM24A-S	859,00
NM24A-SR	1 025,00
NM24A-SR-F	1 025,00



SM 20 Nm	Cena [PLN/szt.] • Price [PLN/pc]
SM230A	841,00
SM230A-S	1 049,00
SM230ASR	1 309,00
SM24A	824,00
SM24A-MA	1 475,00
SM24A-MOD	1 499,00
SM24A-MP	1 285,00
SM24AP5	1 174,00

CM 2 Nm	Cena [PLN/szt.] • Price [PLN/pc]
CM230-F(-L/-R)	499,00
CM230G(-L/-R)	551,00
CM230(-L/-R)	516,00
CM24-F-L	471,00
CM24G(-L/-R)	526,00
CM24G-SR(-L/-R)	755,00
CM24(-L/-R)	488,00
CM24-SR-F(-L/-R)	692,00
CM24-T(-L/-R)	460,00



Siłownik do przepustnic bez sprężyny powrotnej • Actuators for damper without return spring



GM 40 Nm	Cena [PLN/szt.] • Price [PLN/pc]
GM230A	1 478,00
GM230A-TP	1 478,00
GM230G-T	2 950,00
GM24A	1 454,00
GM24A-MOD	2 067,00
GM24A-MP	1 852,00
GM24A-MP-TP	1 852,00
GM24A-SR	1 738,00
GM24A-SR-TP	1 738,00
GM24A-TP	1 454,00
GM24G-MP-T	3 282,00
GM24G-SR-T	3 099,00
GM24G-T	2 929,00

LMQ 4 Nm	Cena [PLN/szt.] • Price [PLN/pc]
LMQ24A	1 181,00
LMQ24A-MF	1 343,00
LMQ24A-SR	1 222,00

LMC 5 Nm	Cena [PLN/szt.] • Price [PLN/pc]
LMC230A (-F)	602,00
LMC24A (-F)	602,00
LMC24A-SR (-F)	807,00

NMQ 8 Nm	Cena [PLN/szt.] • Price [PLN/pc]
NMQ24A	1 302,00
NMQ24A-MF	1 603,00
NMQ24A-SR	1 447,00

NMC 10 Nm	Cena [PLN/szt.] • Price [PLN/pc]
NMC24A-MP	1 195,00

SMQ 16 Nm	Cena [PLN/szt.] • Price [PLN/pc]
SMQ24A	1 420,00
SMQ24A-MF	1 780,00
SMQ24A-SR	1 607,00

SMD 16 Nm	Cena [PLN/szt.] • Price [PLN/pc]
SMD24A	1 139,00

SMD 20 Nm	Cena [PLN/szt.] • Price [PLN/pc]
SMC24A-MP	1 340,00

Wyposażenie • Additional equipment

Typ • Type	Cena [PLN/szt.] • Price [PLN/pc]
UK24BAC	3 019,00
UK24MOD	2 666,00
MFT-C	1 240,00



Siłownik do przepustnic ze sprężyną powrotną • Actuator for dampers with return spring



LF 4 Nm	Cena [PLN/szt.] • Price [PLN/pc]
LF230	987,00
LF230-S	1 122,00
LF24	907,00
LF24-3	1 122,00
LF24-MFT	1 343,00
LF24-S	1 049,00
LF24-SR	1 233,00

TF 2 Nm	Cena [PLN/szt.] • Price [PLN/pc]
TF230	803,00
TF230-S	942,00
TF24	744,00
TF24-3	935,00
TF24-MFT	1 059,00
TF24-S	879,00
TF24-SR	1 008,00



NF 10 Nm	Cena [PLN/szt.] • Price [PLN/pc]
NF24A	1 160,00
NF24A-3	1 624,00
NF24A-MOD	1 897,00
NF24A-MP	1 686,00
NF24A-S2	1 316,00
NF24A-SR	1 381,00
NF24A-SR-S2	1 541,00
NF24A-SZ	1 381,00
NF24A-SZ-S2	1 541,00
NF24G-MP-L	3 102,00
NF24G-SR-L	2 811,00
NF24G-SR-S2-L	3 019,00

SF 20 Nm	Cena [PLN/szt.] • Price [PLN/pc]
SF24A	1 416,00
SF24A-3	1 797,00
SF24A-MOD	2 060,00
SF24A-MP	1 859,00
SF24A-S2	1 568,00
SF24A-SR	1 638,00
SF24A-SR-S2	1 752,00
SF24A-SZ	1 638,00
SF24A-SZ-S2	1 752,00
SF24G-MP-L	3 223,00
SF24G-SR-L	2 922,00
SF24G-SR-S2-L	3 106,00

Klimatyzator ścienny, seria Elite • Split AC **XA71I**



Model	Chłodzenie • Cooling [kW]	Grzanie • Heating [kW]	Średnica rur • Pipes diameter [cale]	Cena katalogowa [PLN/kpl.] • Basic price [PLN/set]
TAC-09CHSD/XA71I	2,6	2,8	1/4 - 3/8	2 150,00
TAC-12CHSD/XA71I	3,5	3,7	1/4 - 3/8	2 590,00
TAC-18CHSD/XA71I	5,1	5,2	1/4 - 3/8	3 870,00
TAC-24CHSD/XA71I	6,8	6,9	1/4 - 1/2	4 650,00

Klimatyzator ścienny, seria Era • Split AC **YA11I**



Model	Chłodzenie • Cooling [kW]	Grzanie • Heating [kW]	Średnica rur • Pipes diameter [cale]	Cena katalogowa [PLN/kpl.] • Basic price [PLN/set]
TAC-09CHSD/YA11I	2,6	2,8	1/4 - 3/8	2 350,00
TAC-12CHSD/YA11I	3,4	3,4	1/4 - 3/8	2 750,00

Jednostka zewnętrzna MULTI SPLIT • External multi split unit

FMA



EKOLOGICZNY
CZYNNIK



AUTORESTART



ODPORNOŚĆ
NA RDZĘ



ENERGO-
OSZCZĘDNY



FUNKCJA
ANTH-CING

Model	Chłodzenie • Cooling [kW]	Grzanie • Heating [kW]	Średnica rur • Pipes diameter [cale]	Cena katalogowa [PLN/szt.] • Basic price [PLN/pc]
FMA-18I2HD/DVO	5,2	5,3	1/4 - 3/8	4 100,00
FMA-27I3HD/DVO	7,9	8,0	1/4 - 3/8	5 800,00
FMA-32I4HD/DVO	9,4	9,5	1/4 - 3/8	6 920,00

Jednostka wewnętrzna ścienna MULTI SPLIT • Internal multi split unit

FMA



I FEEL



I SET



AUTORESTART



WI-FI



INTELIGENY
NAWIEW



TRYB NOCNY



ULTRACZUCHY



AUTO MODE



PAMIĘĆ
ZALUŻY



OBSTRUKCJE
POŁĄCZENIE



5 PRĘDKOŚCI
WENTYLATORA



WYŚWIETLACZ
ON/OFF

Model	Chłodzenie • Cooling [kW]	Grzanie • Heating [kW]	Średnica rur • Pipes diameter [cale]	Cena katalogowa [PLN/szt.] • Basic price [PLN/pc]
FMA-09CHSA/DVI	2,6	2,6	1/4 - 3/8	960,00
FMA-12CHSA/DVI	3,5	3,5	1/4 - 3/8	1 100,00
FMA-18CHSA/DVI	5,0	5,0	1/4 - 3/8	1 180,00



Klimatyzator przenośny • Portable AC

LIN



WI-FI



SAMOODPAROWANIE



CHŁODZENIE



GRZANIE



INTELIGENTNY NAWIEW



INTELIGENTNE OSUSZANIE



TRYB NOCNY



24 TIMER



EKOLOGICZNY CZYNNIK

Model	Chłodzenie • Cooling [kW]	Grzanie • Heating [kW]	Średnica rur • Pipes diameter [cale]	Cena katalogowa [PLN/szt.] • Basic price [PLN/pc]
LIN-12LHPB/KA	3,2	2,9	-	2 280,00



Klimatyzator ścienny



Model	Chłodzenie [kW]	Grzanie [kW]	Średnica rur [cale]	Cena katalogowa [PLN/kpl.]
MIS-09CHSD/TP11	2,60	2,63	1/4 - 3/8	2 100,00
MIS-12CHSD/TP11	3,40	3,43	1/4 - 3/8	2 200,00
MIS-18CHSD/TP11	5,10	5,13	1/4 - 3/8	3 710,00
MIS-24CHSD/TP11	6,84	7,05	1/4 - 1/2	4 600,00

Klimatyzator kanałowy

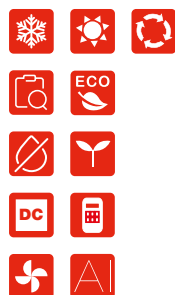

Model	Chłodzenie [kW]	Grzanie [kW]	Średnica rur [cale]	Cena katalogowa [PLN/kpl.]
MIS-12D2HRH/DV	3,40	3,42	1/4 - 1/2	4 500,00
MIS-18D2HRH/DV	5,10	5,13	1/4 - 1/2	4 800,00
MIS-24D2HRH/DV	7,04	7,62	1/4 - 1/2	5 500,00
MIS-36D2HRH/DV	10,55	11,50	3/8 - 5/8	8 300,00



Klimatyzator kasetonowy

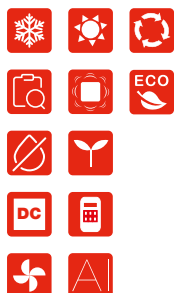

Model	Chłodzenie [kW]	Grzanie [kW]	Średnica rur [cale]	Cena katalogowa [PLN/kpl.]
MIS-12CHRH/DV	3,40	3,42	1/4 - 1/2	4 450,00
MIS-18CHRH/DV	5,28	5,80	1/4 - 1/2	5 100,00
MIS-24CHRH/DV	7,04	7,62	1/4 - 1/2	6 300,00
MIS-36CHRH/DV	10,55	11,50	1/4 - 1/2	9 000,00
MIS-42CHRH/DV7	12,31	13,50	3/8 - 5/8	12 000,00

Moduł Wi-Fi do klimatyzatora ściennego (pendrive USB)



Produkt	Cena katalogowa [PLN/szt.]
Moduł WiFi	140,00

Rura miedziana chłodnicza z izolacją • Insulated copper cooling pipes

Rura miedziana wykonana zgodnie z normą UNI-EN 12735-1.

Przeznaczona do dystrybucji czynników chłodniczych.

Wyżarzana w zwojach, uszczelniona na końcach w celu zachowania czystej i suchej powierzchni wewnętrznej.

Odpowiednia grubość izolacji zapobiega kondensacji wody w normalnych warunkach pracy: temperatura płynu w rurze wyższa lub równa 7°C, temperatura wewnątrz pomieszczenia 27°C, wilgotność względna wewnątrz niższa lub równa 50%.

Wymiary podane w calach.

A copper pipe made in accordance with UNI-EN 12735-1.

Designed for the distribution of cooling media.

Annealed in coils, sealed at ends to keep the internal surface clean and dry.

The appropriate thickness of insulation prevents water condensation under normal working conditions: the temperature of liquid in the pipe at least 7°C, temperature inside the room 27°C, internal relative humidity lower or equal to 50%.

Dimensions in inches.

Typ • Type	Kraż • Coils [mb]	Cena katalogowa [PLN/opak.] • Basic price [PLN/pack.]
Rura miedziana chłodnicza z izolacją • Insulated copper cooling pipe		
Rura miedziana 1/4"	25	620,65
Rura miedziana 3/8"	25	930,88
Rura miedziana 1/2"	25	1 228,74
Rura miedziana 5/8"	25	1 867,98
Rura miedziana 3/4"	25	2 345,99
Rura miedziana 7/8"	25	3 081,53

Czynnik chłodniczy • Refrigerant



Produkt posiada kartę bezpieczeństwa, dokument dopuszczający do stosowania czynnika na terenie Polski.

W przypadku zwrotu butli w terminie:

- do 6 miesięcy od daty zakupu - zwracamy 100% wartości kaucji,
- do 12 miesięcy od daty zakupu - zwracamy 50% wartości kaucji,
- powyżej 12 miesięcy od daty zakupu - zwracamy 20% wartości kaucji.

The product has the MSDS, marketing authorization for use in Poland.

In case of returning the container within:

- 6 months since purchase - we give 100% of its price back,
- 12 months since purchase - we give 50% of the deposit back,
- more than 12 months since purchase - we give 20% of the deposit back.

Typ • Type	Wielkość butli • Cylinder size	Cena butli • Cylinder price [PLN]	Ilość czynnika • Quantity refrigerant [kg]	Cena katalogowa [PLN/opak.] • Basic price [PLN/pack.]
R32 Butla wielorazowa • Multiple-use cylinder	10	150,00	9,0	na zapytanie ofertowe
R134A Butla wielorazowa • Multiple-use cylinder	10	150,00	11,0	
	20	150,00	25,0	
R407C Butla wielorazowa • Multiple-use cylinder	10	150,00	11,0	
	20	150,00	25,0	
R410A Butla wielorazowa • Multiple-use cylinder	10	150,00	9,8	
	10	150,00	11,0	
	20	150,00	25,0	

Uwaga! Możliwy jest zakup czynnika w zbiornikach tonowych.

Mocowanie skraplacza - Condenser fixing

SL

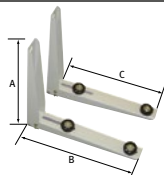

Łapy składane WZMOCNIONE śrubami, malowane proszkowo RAL1013.
Możliwość regulacji rozstawu amortyzatorów.
Kompletny zestaw przygotowany do montażu
(kołki rozporowe, wkręty, amortyzatory).

Folded arms connected by 3 screws, powder painted (RAL 1013).
Possible adjustment of spacing between the fixing shock absorbers
A complete set ready for installation (installation plugs, screws, shock absorbers).

Typ • Type	Udźwig • Max. load [kg]	Wysokość • Height [cm]	Długość łap • Feet length [cm]	Szt./opak. • pc/pack	Cena [PLN/kpl.] • Price [PLN/set.]
SL 430	110	39	43	12	86,90
SL 450	120	39	45	4	99,59
SL 550	170	49	55	4	126,45

Mocowanie skraplacza z poprzeczką i poziomnicą - Condenser tie

HB



Poprzeczka z możliwością regulacji mocowania.
Łapy składane, malowane proszkowo RAL 1013.
Możliwość regulacji rozstawu amortyzatorów mocujących.
Poprzeczka mocująca wyposażona w poziomnicę.
Kompletny zestaw przygotowany do montażu
(kołki rozporowe, wkręty, amortyzatory).

A crossbar with adjustable fastening length.
Folded arms, powder painted (RAL 1013).
Possible adjustment of spacing between the fixing shock absorbers.
A complete set ready for installation (installation plugs, screws, shock absorbers).

Typ • Type	Udźwig • Max. load [kg]	Wysokość • Height [cm]	Długość łap • Feet length [cm]	Długość poprzeczki • Crossbar [cm]	Cena [PLN/kpl.] • Price [PLN/set.]
HB 420	120	37,5	42	79	127,58
HB 550	160	37,5	55	96	154,99

Wspornik pod skraplacz - PVC holder

PVC



Wykonanie z PVC zapewnia brak wystąpienia korozji.
Komórkowa struktura niweluje potrzebę stosowania podkładek amortyzujących.

PCV holder, no corrosion.

Cellular structure makes shock absorbing washers unnecessary.

Typ • Type	Wymiary • Dimensions [cm]	Udźwig • Max. load [kg]	Szt./opak. • pc/pack	Cena [PLN/szt.] • Price [PLN/pc]
PVC 351SP Wspornik • holder	350 × 80	200	24	28,09
PVC 451SP Wspornik • holder	450 × 80	200	24	37,05
PVC 342TS Zaślepka • hole plug	x	x	24	7,59

Koryto montażowe PVC + nastawna złączka PVC

• PVC trough + adjustable PVC connector

STANDARD BCF

Koryta oprócz łatwości montażu i estetycznego wyglądu posiadają folię ochronną, która zabezpiecza je przed uszkodzeniem podczas przechowywania, transportu i montażu.

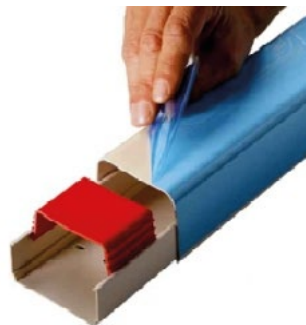

Typ • Type	Długość • Length [m]	Szerokość • Width [mm]	Wysokość • Height [mm]	Cena • Price [PLN]
PVC 0312BC Koryto • Trough	2	25	25	10,43 / m



Typ • Type	Długość • Length [m]	Szerokość • Width [mm]	Wysokość • Height [mm]	Cena • Price [PLN]
PVC 0612BCF Koryto • Trough	2	60	45	22,77 / m
PVC 0603ST Złączka nastawna • Adjustable connector	x	60	x	1,58 / szt. • pc



Typ • Type	Długość • Length [m]	Szerokość • Width [mm]	Wysokość • Height [mm]	Cena • Price [PLN]
PVC 0712BCF Koryto • Trough	2	70	55	26,63 / m
PVC 0703ST Złączka nastawna • Adjustable connector	x	70	x	1,71 / szt. • pc



Typ • Type	Długość • Length [m]	Szerokość • Width [mm]	Wysokość • Height [mm]	Cena • Price [PLN]
PVC 0812BCF Koryto • Trough	2	80	60	32,18 / m
PVC 0803ST Złączka nastawna • Adjustable connector	x	80	x	2,04 / szt. • pc



Typ • Type	Długość • Length [m]	Szerokość • Width [mm]	Wysokość • Height [mm]	Cena • Price [PLN]
PVC 0912BCF Koryto • Trough	2	90	65	37,84 / m
PVC 0903ST Złączka nastawna • Adjustable connector	x	90	x	1,93 / szt. • pc



Typ • Type	Długość • Length [m]	Szerokość • Width [mm]	Wysokość • Height [mm]	Cena • Price [PLN]
PVC 1212BCF Koryto • Trough	2	110	75	46,00 / m
PVC 1203ST Złączka nastawna • Adjustable connector	x	110	x	2,27 / szt. • pc



Typ • Type	Długość • Length [m]	Szerokość • Width [mm]	Wysokość • Height [mm]	Cena • Price [PLN]
PVC 1412BCF Koryto • Trough	2	140	90	70,36 / m
PVC 1403ST Złączka nastawna • Adjustable connector	x	140	x	2,72 / szt. • pc

Narożnik zewnętrzny PVC

• External PVC corner



Typ • Type	Szerokość • Width [mm]	Op. ¹⁾	Cena [PLN/szt.] • Price [PLN/pc]
0306AE	25	20	7,48
0606AE	60	12	13,26
0706AE	70	12	14,17
0806AE	80	9	15,07
0906AE	90	9	16,09
1206AE	110	6	19,03
1406AE	140	6	24,70

Narożnik wewnętrzny PVC

• Internal PVC corner

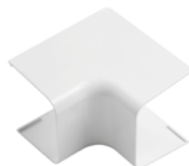

Typ • Type	Szerokość • Width [mm]	Op. ¹⁾	Cena [PLN/szt.] • Price [PLN/pc]
0305AI	25	20	7,48
0605AI	60	8	13,26
0705AI	70	8	14,17
0805AI	80	6	15,07
0905AI	90	6	16,09
1205AI	110	4	19,03
1405AI	140	4	24,70

Łuk PVC • PVC bend



Typ • Type	Szerokość • Width [mm]	Op. ¹⁾	Cena [PLN/szt.] • Price [PLN/pc]
0307CP	25	20	7,37
0607CP	60	10	15,07
0707CP	70	10	16,31
0807CP	80	8	20,85
0907CP	90	8	22,21
1207CP	110	6	27,42
1407CP	140	6	38,07

Dekiel PVC • PVC end cap



Typ • Type	Szerokość • Width [mm]	Op. ¹⁾	Cena [PLN/szt.] • Price [PLN/pc]
0308TT	25	20	7,48
0608TT	60	12	13,26
0708TT	70	12	13,83
0808TT	80	9	15,30
0908TT	90	9	15,75

¹⁾ Ilość [szt./opak.] • Quantity [pcs/pack.]

Kolano przyścienne PVC

• Wall side PVC bend



Typ • Type	Szerokość • Width [mm]	Op. 7	Cena [PLN/szt.] • Price [PLN/pc]
0609CM	60	9	19,26
0709CM	70	9	20,50
0809CM	80	6	23,79
0909CM	90	6	25,38
1209CM	110	4	29,46
1409CM	140	4	41,24

Przeście ścienne PVC

• PVC thru-wall passage



Typ • Type	Szerokość • Width [mm]	Op. 7	Cena [PLN/szt.] • Price [PLN/pc]
0610PM	60	10	14,28
0710PM	70	10	15,07
0810PM	80	8	18,36
0910PM	90	8	19,37
1210PM	110	8	24,37
1410PM	140		34,10

Opaska łącząca PVC

• PVC connecting band



Typ • Type	Szerokość • Width [mm]	Op. 7	Cena [PLN/szt.] • Price [PLN/pc]
0304GC	25	20	7,48
0604GC	60	30	6,91
0704GC	70		7,48
0804GC	80	30	9,06
0904GC	90	30	9,64
1204GC	110	20	10,20
1404GC	140		13,37

Trójnik PVC

• PVC T connection



Typ • Type	Szerokość • Width [mm]	Op. 7	Cena [PLN/szt.] • Price [PLN/pc]
0813DT	80	4	35,35
0913DT	90	4	38,18
1213DT	110	2	44,19
1413DT	140	2	61,86

Łącznik PVC

• PVC connector



Typ • Type	Szerokość • Width [mm]	Op. 7	Cena [PLN/szt.] • Price [PLN/pc]
0611GF	60	6	27,42
0811GF	80	4	31,38

MATERIAŁY MONTAŻOWE DO KLIMATYZATORÓW

Rura do odprowadzania skroplin, pompka skroplin

• Pipe for drips, condensate removal pump



Rura do odprowadzania skroplin • Pipe for drips



Typ • Type	Szerokość • Width [mm]	Op. 7)	Cena [PLN/szt.] • Price [PLN/pc]
0016TU	16	30	127,80
0018TU	18	30	157,72
0020TU	20	30	175,73

Pompka skroplin • Condensate removal pump

MINI DROP

Pompki skroplin montowane nad sufitem podwieszanym lub w korytach montażowych.

Wymiary (wys. x szer. x głęb.): 65 x 104 x 32 mm.

Waga: 0,25 kg.

Zewnętrzna średnica rury: 6mm.

Zasilanie: 230V, 50-60Hz.

Zużycie energii: 16W .

Znak CE.

W komplecie znajdują się: pompka skroplin, komplet kabli zasilających, zbiornik na skropliny, rurka wlotowa, rurka odpowietrzająca, podkładki antywibracyjne, opaski nylonowe.

The Mini Pump is designed to be installed: above the false ceiling where possible or in plastic conduit.

Size (HxWxD): 65x104x32 mm.

Weight: 0.25 kg.

Outlet tube size: 6mm i/d.

Power: 230V AC 50-60Hz 16W.

CE marked.

Includes: pump, power cable, reservoir, inlet tube, breather tube, cable ties, AV pad.



Nazwa • Name	Cena [PLN/szt.] • Price [PLN/pc]
MINI DROP	334,13

FRIONETT® ACTIV

koncentrat

5 l



Cena [PLN/szt.] • Price [PLN/pc]
350,10

NANOCLEAN AIR

koncentrat Lawenda / Orchidea / bezzapachowy

1 l



Cena [PLN/szt.] • Price [PLN/pc]
198,62

Opakowania zbiorcze • Collective packaging measurements

P1

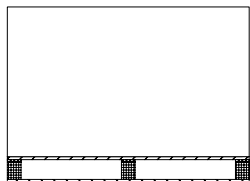

Widok z boku



Widok z góry

P2

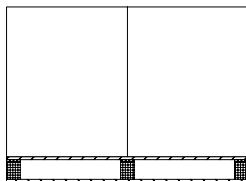

Widok z boku

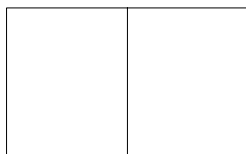

Widok z góry

P4

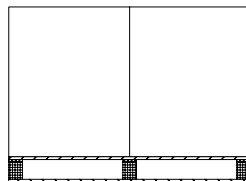

Widok z boku

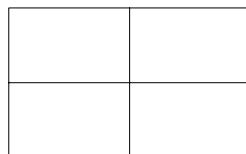

Widok z góry

P6

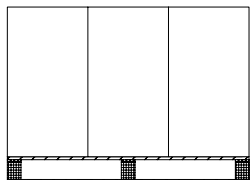

Widok z boku

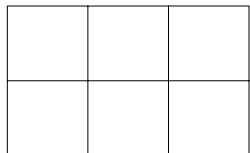

Widok z góry

P12

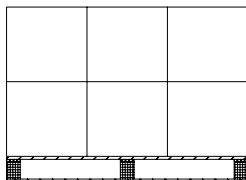

Widok z boku



Widok z góry

Kod • Code	Długość • Length [mm]	Szerokość • Width [mm]	Wysokość • Height [mm]	Waga • Weight [kg]	Objętość • Volume [m ³]	Opak./paleta • Box/pallet [m ³]	Cena [PLN/szt.] • Price [PLN/pc]
P1	1200	800	800	4,63	0,770	1	32,59
P2	600	800	800	2,83	0,380	2	20,91
P4	600	400	800	1,34	0,190	4	10,35
P6	400	400	800	1,04	0,130	6	8,35
P12	400	400	400	0,71	0,064	12	6,23

ZAMÓWIENIE POWYŻEJ 24 000 PLN DOSTAWA GRATIS

- Odbiór własny z magazynu Lindab Sp. z o.o.:
WIERUCHÓW: ul. Sochaczewska 144, poniedziałek - piątek: 8:00 - 16:00,
KRAKÓW: Liszki k. Krakowa, Morawica 356, poniedziałek - piątek: 8:00 - 16:00.
- Wysyłka firmą spedycyjną na koszt odbiorcy.
Odbiorca ma prawo zamówić dowolną firmę transportową.
- Wysyłki transportowe zryczałtowane, w dowolny punkt w Polsce, na zasadach:

WARTOŚĆ ZAMÓWIENIA NETTO PLN	ZRYCZAŁTOWANY KOSZT TRANSPORTU
0 - 4 000	koszt transportu 7% wartości netto (minimum 250 zł)
UWAGA - jeśli wysyłany towar nie jest objętościowy lub ciężki i rzeczywiste koszty spedycji są znacznie niższe od kosztów zryczałtowanych - klient zostanie obciążony niższym kosztem rzeczywistym	
4 001 - 8 000	koszt transportu 6% wartości netto (minimum 300 zł)
8 001 - 15 000	koszt transportu 5% wartości netto (minimum 450 zł)
15 001 - 24 000	koszt transportu 4% wartości netto
> 24 000	DOSTAWA BEZPŁATNA

UWAGI:

- Zryczałtowane koszty transportu obowiązują na terenie całej Polski i są takie same dla dowolnego punktu w kraju.
- Lindab Sp. z o.o. zobowiązuje się, że transport zgodnie ze zryczałtowanymi kosztami transportu zostanie zrealizowany w maksimum 7 dni roboczych.
- Zryczałtowanych kosztów transportu nie można używać do produktów gabarytowych tzn.:
 - rur spiro powyżej średnicy 315 mm,
 - kanałów i kształtek prostokątnych,
 - profili stalowych i kanałowych
 oraz do ofert specjalnych gdzie wyraźnie zostało zaznaczone, że koszt transportu będzie określany oddzielnie.
Koszty transportu na wyżej wymienione produkty podlegają kalkulacji indywidualnej.
- Zamówienia na materiały izolacyjne o wartości powyżej 7 000 zł netto dostarczane są bezpłatnie w dowolny punkt Polski (dotyczy zamówień realizowanych bezpośrednio z firmy Rockwool).
- Koszty dostawy ekspresowej określane są indywidualnie.

Dodatkowe informacje można uzyskać kontaktując się z naszym DZIAŁEM HANDLOWYM:

**WIERUCHÓW
KRAKÓW**

tel.: (22) 250 50 50
tel.: 506 28 28 38

fax: (22) 250 50 60

